

2026

YOUR RIDE **YOUR** PERFORMANCE **OUR** PASSION





Bonamici Racing components were used by ROKIT BMW Motorrad WorldSBK Team and Toprak Razgatlıoğlu for the victory of the 2025 Superbike world championship

TECHNICAL PARTNERSHIP

WorldSBK - WorldSSP



BMW MOTORRAD
WorldSBK Team

ROKiT



ALTHEA
Racing

CIV Superbike

Sport Bike ESBK



We are the official supplier of important teams within the world of international competitions. Race tracks are the best test bench for our high performance components.

Siamo fornitori ufficiali di importanti Team nel mondo delle competizioni internazionali. I circuiti di gara sono il miglior banco prova per i nostri componenti ad alte prestazioni.

INDEX - INDICE

ABOUT US - CHI SIAMO	7
REARSETS - PEDANE	8
ENGINE PROTECTIONS - PROTEZIONI MOTORE	28
DASHBOARD PROTECTIONS - PROTEZIONI STRUMENTAZIONE	44
TOP TRIPLE CLAMP - PIASTRE DI STERZO SUPERIORI	48
LEVERS - LEVE	52
COMPLETE CLUTCH LEVERS - LEVE FRIZIONE COMPLETE	64
BRAKE LEVER WITH REMOTE ADJUSTER - LEVE FRENO CON REGISTRO REMOTO	66
REMOTE ADJUSTER - REGISTRO REMOTO	67
LEVER PROTECTIONS - PROTEZIONE LEVE	70
CLIP-ONS - SEMIMANUBRI	76
CHAIN ADJUSTER - TENDICATENA	80
FLUID RESERVOIRS - SERBATOI FLUIDO	84
SWINGARMS SPOOL - SUPPORTI CAVALLETTO	88
MIRROR BLOCKS - TAPPI SPECCHIETTO	92
OIL CAPS - TAPPI OLIO	94
TANK CAPS - TAPPO SERBATOIO	96
MERCHANDISING	100
MODELS - MODELLI	104

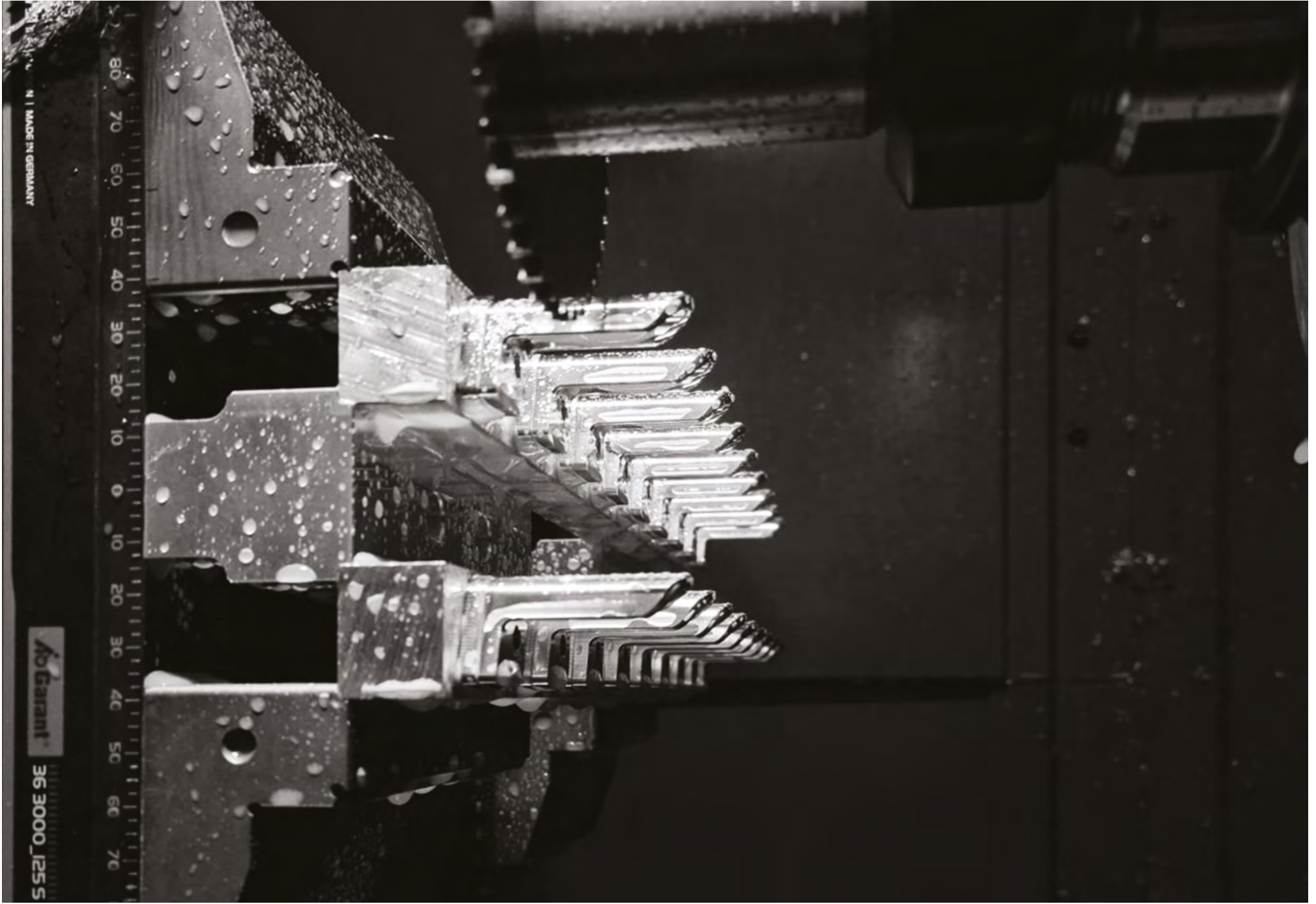



Design Progettazione

Every single detail of our products is the result of an accurate engineering design process, we develop the racing components that weigh no one gram more than necessary. The beauty of the lightness became tangible throughout the design, perspective and lines have been drawn to push over the performance.

Anche il più piccolo dettaglio dei nostri prodotti è il risultato di un accurato processo di progettazione, sviluppiamo componenti da competizione che non pesano un grammo più del necessario. La bellezza della leggerezza è resa tangibile attraverso il design, prospettiva e linee sono tracciate per andare oltre le prestazioni.



Production Realizzazione

We use the best technologies to produce the racing accessories with maximum care possible. By making a constant quality-oriented investments, by using of CNC machines and the best titanium, aluminum and steel alloys, we make high technology accessories to obtain the best performance during the race competitions.

Usiamo le migliori tecnologie per produrre accessori per moto in maniera accurata. Attraverso investimenti sulla qualità, l'uso di macchine a controllo numerico e le migliori leghe di titanio, alluminio e acciaio, produciamo accessori altamente performanti, in modo da ottenere il massimo delle prestazioni durante le competizioni motociclistiche.



Assistance Assistenza

We are ever ready to assist our customers and to provide them with the best solutions to optimize their mode to run the bike. We are able to develop new racing accessories and improve our products based on the reciprocal feedback. Our aftersales staff can solve any problems with maximum care and efficiency possible.

Siamo sempre pronti ad aiutare i nostri clienti per dargli le migliori soluzioni in grado di ottimizzare il loro modo di correre in moto. Siamo in grado di sviluppare nuovi accessori da corsa e migliorare i nostri prodotti attraverso il feedback costante tra noi ed i nostri clienti. Il nostro personale post-vendita è in grado di risolvere tutti i problemi con la massima cura ed efficienza possibile.



Tradition Tradizione

The Italian culture leads us to appreciate the beauty that is transmitted in all our products. We produce our accessories in Italy with the respect of Italian tradition. The history teaches us to create new items using the ingredients that brought Italy a fame in the field of race competitions.

La cultura italiana ci ha dato il senso del bello che noi trasmettiamo a tutti i nostri prodotti. Produciamo i nostri accessori in Italia con il rispetto della tradizione italiana, la storia ci insegna a fare nuovi oggetti, con tutti gli ingredienti che hanno reso l'Italia famosa nel mondo delle competizioni.

REARSETS - PEDANE

REARSETS TECHNICAL FEATURES

- High performance aluminum
- Double ball bearings
- Racing foot pegs with high grip
- Wide adjustment of the foot pegs position
- Hard anodic oxidation treatment
- Shift lever adjustable
- Break point of the foot pegs
- Non-slip rubber tip

REARSETS CARATTERISTICHE TECNICHE

- Alluminio ad alte prestazioni
- Doppi cuscinetti a sfera
- Poggiapiedi racing ad alto grip
- Regolazione della posizione del poggiapiedi
- Trattamento di ossidazione anodica dura
- Leva del cambio regolabile
- Punto di rottura del poggiapiedi
- Punta in gomma antiscivolo

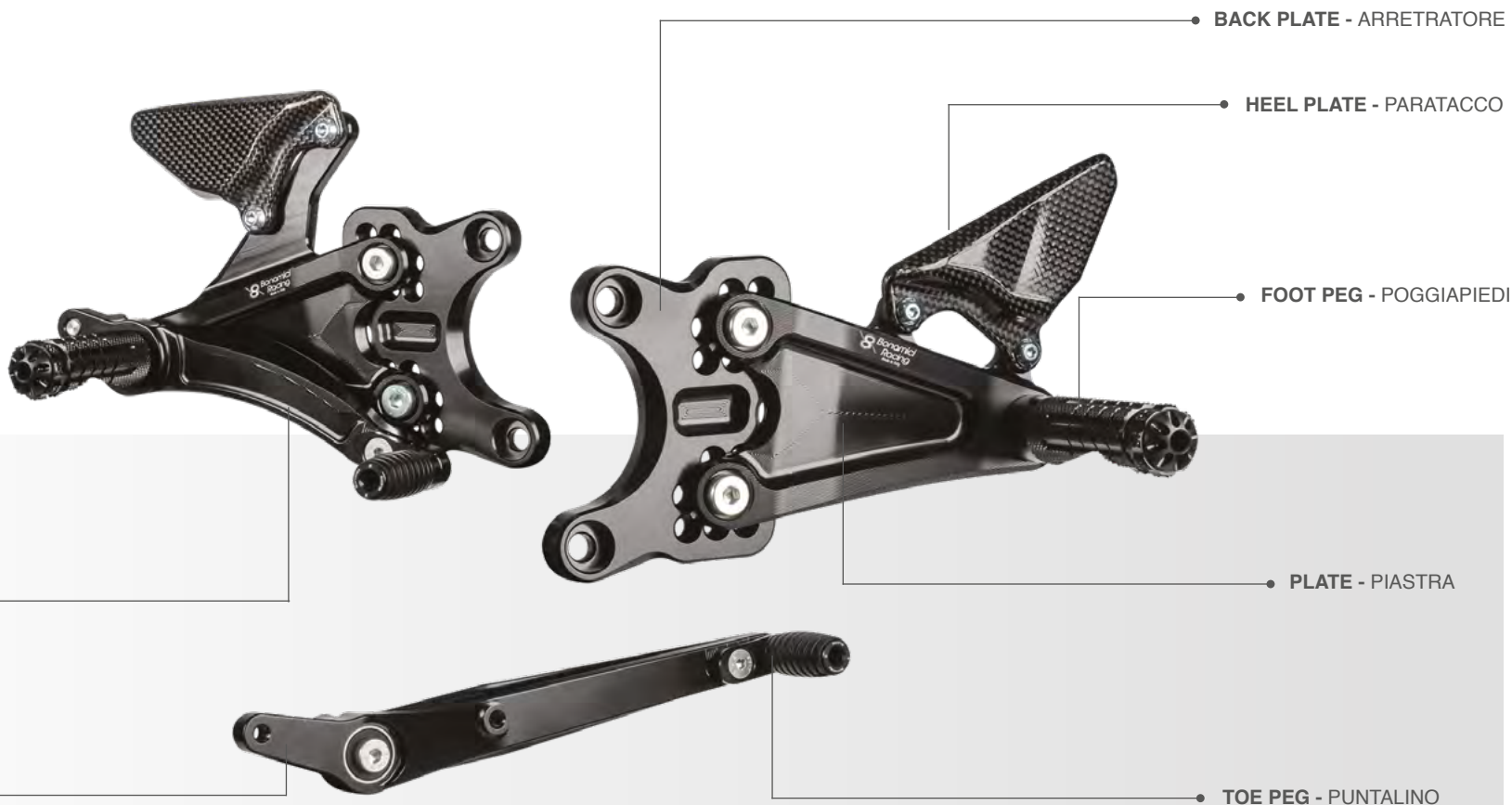

Bonamici Racing designs and manufactures rearsets for most of the models of sport-bikes on the market since 1994.

Made from billet high-strength aluminum alloys with CNC technology, Bonamici Racing rearsets have many peculiarities, among them there is the use of ball bearings to completely eliminate friction on the levers, spring for the assisted return of the rear brake lever and the possibility of adjustment in different positions.

All the rearsets in our catalog are anodized in black to have greater mechanical resistance and greater resistance to the chemical agents, in addition we have the possibility of customizing the platforms in many ways.

Bonamici Racing progetta e realizza pedane poggiapiedi per la maggior parte di modelli di moto sportive presenti sul mercato dal 1994.

Realizzate dal pieno in leghe di alluminio ad alta resistenza con tecnologia CNC, le pedane Bonamici Racing hanno molte peculiarità, tra queste vi è l'uso di cuscinetti a sfera per eliminare completamente gli attriti sui leveraggi, molla per il ritorno assistito della leva freno posteriore e la possibilità di regolazione in differenti posizioni.

Tutte le pedane presenti in catalogo sono anodizzate nel colore nero per avere una maggiore resistenza meccanica ed agli agenti chimici, inoltre c'è la possibilità di personalizzare le pedane in tanti modi.



NOTES - NOTE

A: remove the sprocket protection (only for reverse shifting) - rimuovere il carter copripignone (solo per cambio rovesciato)
B: remove the sprocket protection - rimuovere il carter copripignone
C: remove the plastic protection from the exhaust - rimuovere la protezione in plastica sullo scarico
D: remove the lateral stand - rimuovere il cavalletto laterale
D1: remove the lateral stand (only for reverse shifting) - rimuovere il cavalletto laterale (solo per cambio rovesciato)
F: includes the gear selector - include il selettore cambio
G: includes the rear Rear brake fluid reservoirs - include il Serbatoio fluido freno posteriore
H: includes the warm carbon protection - include il paracalore in carbonio
I: includes carbon heel plates - include i paratacchi in carbonio
L: it is not possible to mount the hydrostop - non è possibile montare l'hydrostop
M: it need to modify the original fairing - occorre modificare le carene originali

N: can use in normal shifting mode - può funzionare con il cambio normale
O: it need to change the rear brake tube - è necessario sostituire il tubo freno posteriore
P: it's possible to mount carbon heel plates accessories - è possibile montare i paratacchi in carbonio come accessorio
R: can use in reverse shifting mode - può funzionare con il cambio rovesciato
T: it is not necessary to mount the hydrostop - non è necessario montare l'hydrostop
V: Includes folding foot pegs - Include poggia piedi chiudibili
W: it is possible to mount folding foot pegs without modifying the plate, see the table "folding foot pegs" on page 24 and page 25
 è possibile montare il poggia piedi chiudibile senza modificare la pedana, consultare la tabella "poggia piedi chiudibili" a pagina 24 e pagina 25

Please note: some models with and without ABS may need to replace the rear brake tubes
 Attenzione: per alcuni modelli con e senza ABS potrebbe essere necessario sostituire i tubi freni posteriori

APRILIA

MODEL - MODELLO	FROM - DAL	TO - AL	CODE - CODICE	€	NOTES - NOTE
RSV4 - RSV4 RF - RSV4 Factory - Tuono V4 (standard)	2017	2024	A005S	598,00	N/P/T/W
RSV4 - RSV4 RF - RSV4 Factory - Tuono V4 (reverse)	2017	2024	A005SR	598,00	R/P/T/W
RS 660 - Tuono 660	2020	2025	A006	779,00	N/P/R/T/W



APRILIA RSV4 FACTORY
RSV4 RF - TUONO - cod. A005S

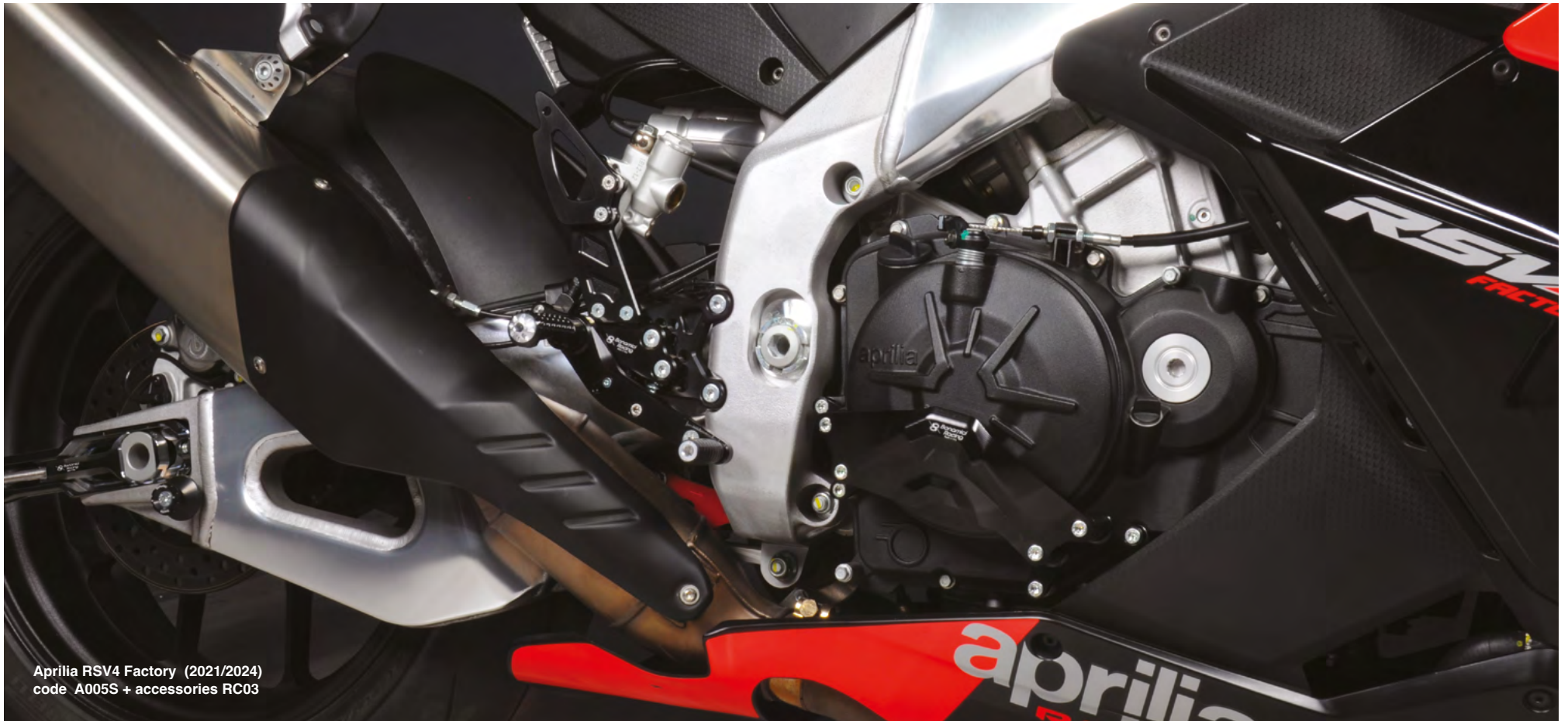

Aprilia RSV4 Factory (2021/2024)
code A005S + accessories RC03

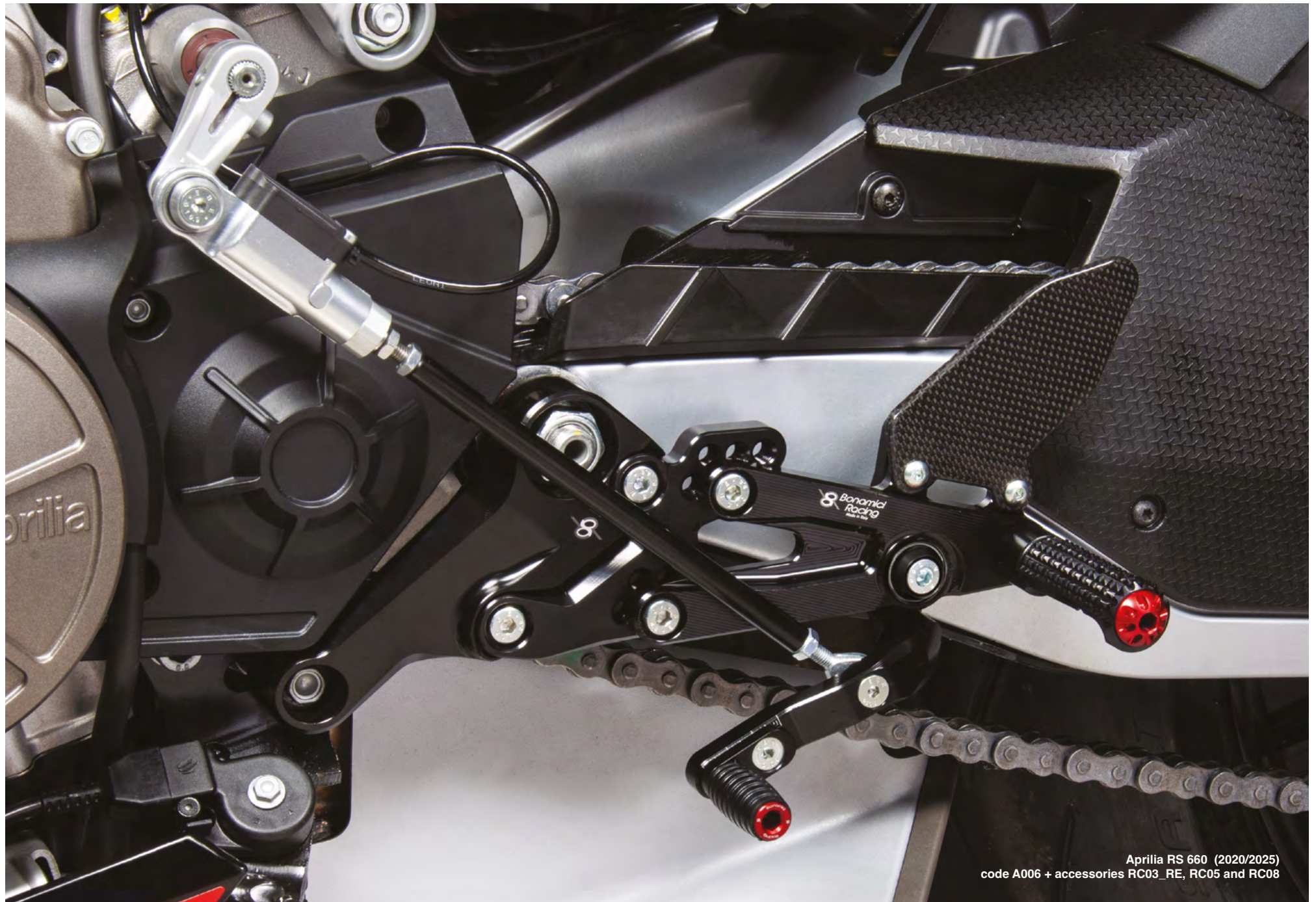

Aprilia RS 660 (2020/2025)
code A006 + accessories RC03_RE, RC05 and RC08

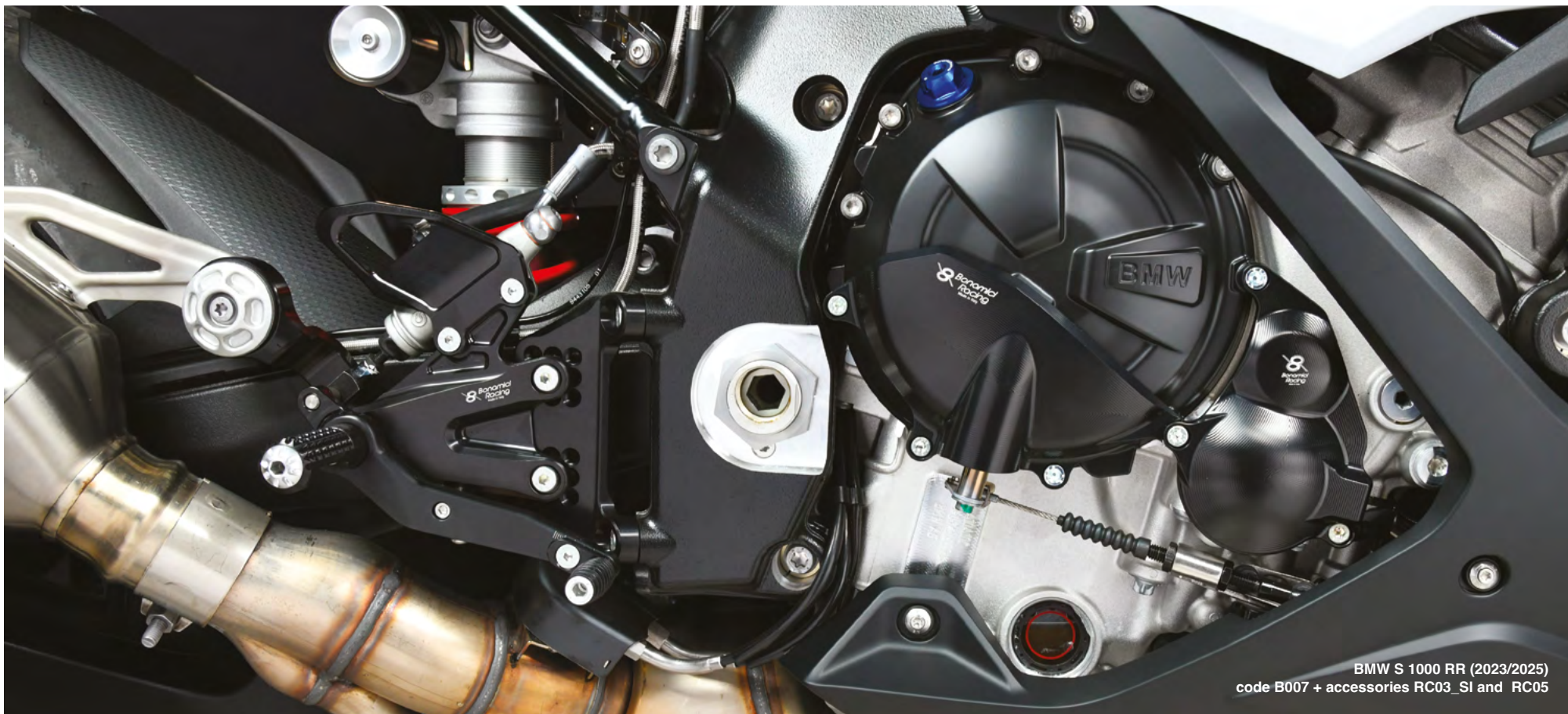

BMW S 1000 RR (2023/2025)
code B007 + accessories RC03_SI and RC05



● BMW S 1000 RR - cod. B007

BMW

MODEL - MODELLO	FROM - DAL	TO - AL	CODE - CODICE	€	NOTES - NOTE
S 1000 RR	2015	2018	B005	524,00	N/R/P/W
S 1000 RR	2019	2025	B007	699,00	N/R/P/T/W
M 1000 RR	2021	2025	B007	699,00	N/R/P/T/W
S 1000 R - M 1000 R	2021	2025	B008	699,00	N/R/P/T/W
S 1000 XR	2020	2025	B009	713,00	N/P/T/V

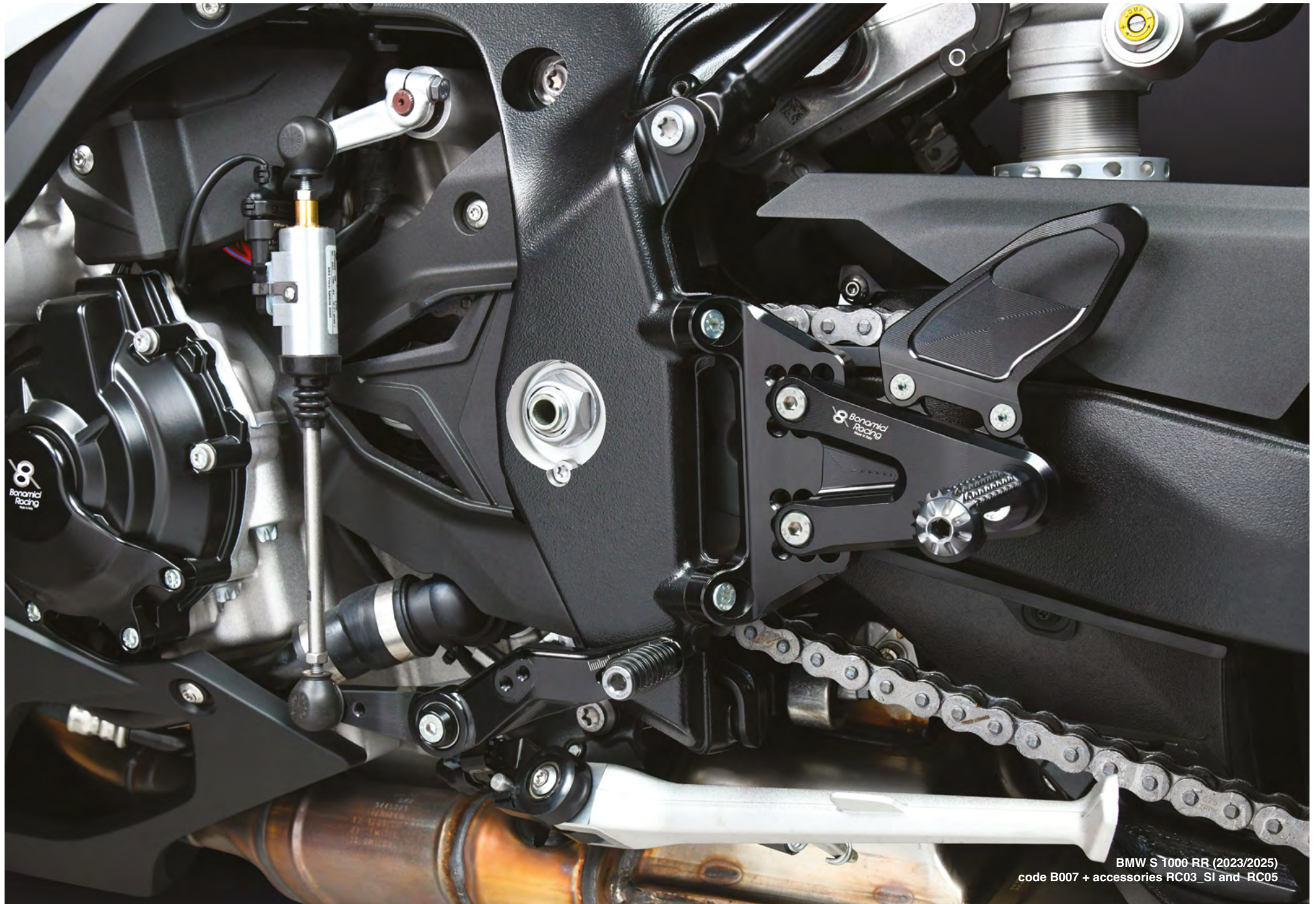

BMW S 1000 RR (2023/2025)
code B007 + accessories RC03 -SI and -RC05

Ducati Streetfighter V4 (2025)
code D002

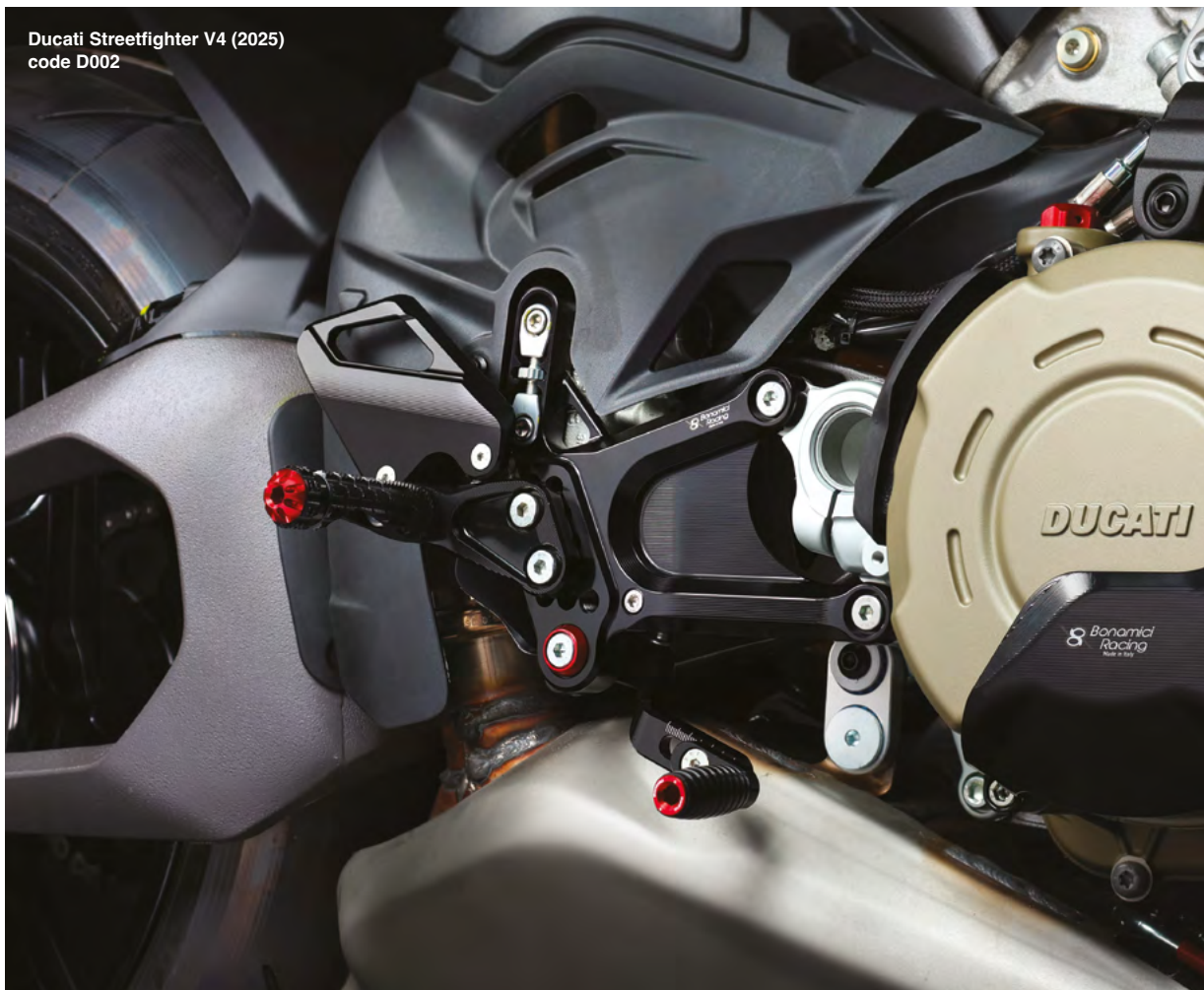

DUCATI PANIGALE V2 (2020/2024) - cod. DV2



DUCATI PANIGALE V4 (2018/2024) - cod. DV4



DUCATI PANIGALE V4 (2025) - cod. D001

PRICES WITHOUT VAT - PREZZI IVA ESCLUSA

DUCATI

MODEL - MODELLO	FROM - DAL	TO - AL	CODE - CODICE	€	NOTES - NOTE
899 / 959 / 1199 / 1299 Panigale	2012	2018	DV2	671,00	N/R/W
Panigale V2	2020	2024	DV2	671,00	N/R/W
Panigale V4 / V4S / V4R	2018	2024	DV4	800,00	N/R/P/W
Panigale V4 / V4S	2025	2025	D001	960,00	N/R/F/T/W
Streetfighter V2	2022	2024	DSTR3	715,00	N/R/W
Streetfighter V4	2020	2024	DSTR2	800,00	N/R/P/W
Streetfighter V4 / V4S	2025	2025	D002	960,00	N/R/T/W



Ducati Panigale V4/V4S (2025)
code D001

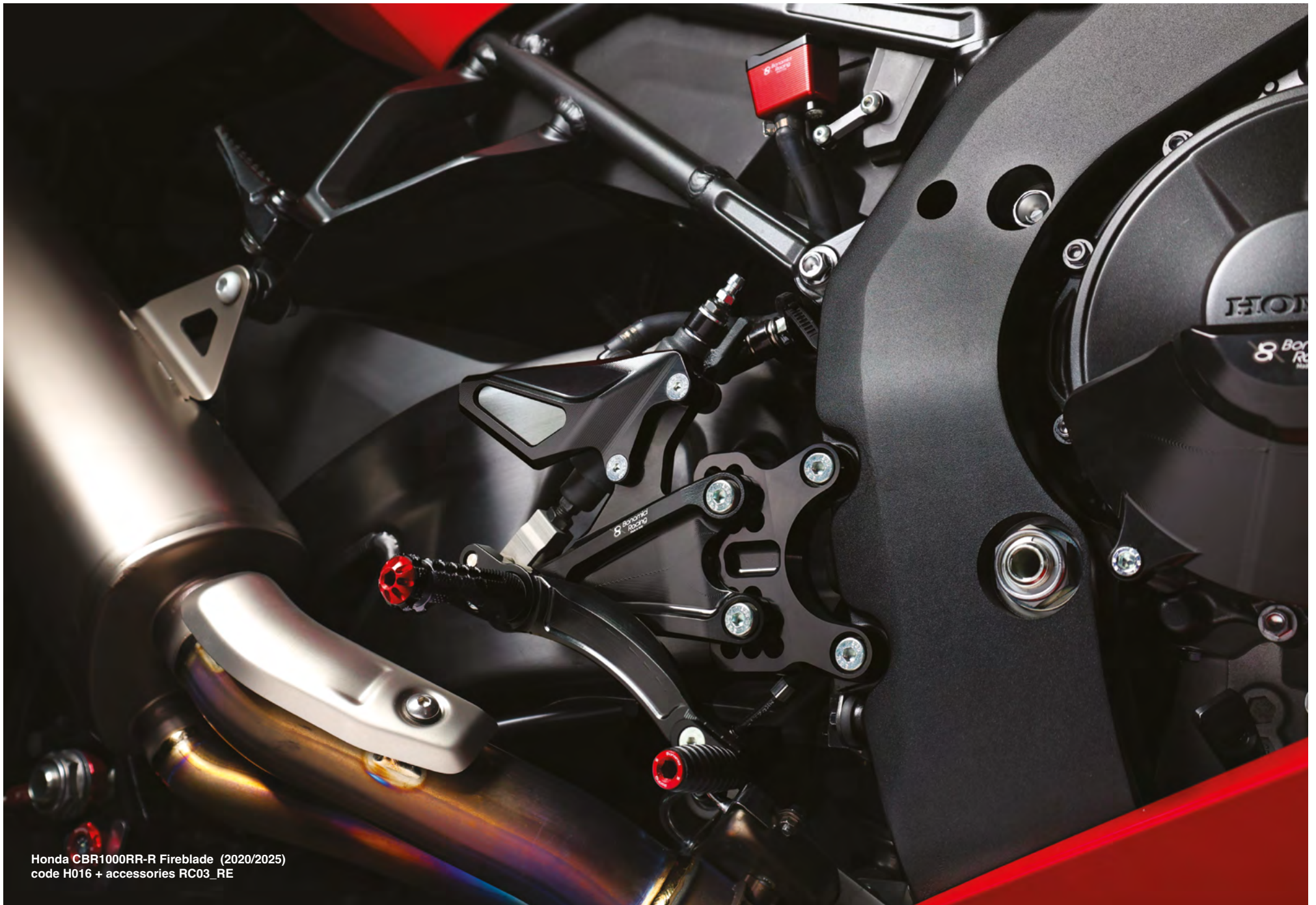

Honda CBR1000RR-R Fireblade (2020/2025)
code H016 + accessories RC03_RE

HONDA

MODEL - MODELLO	FROM - DAL	TO - AL	CODE - CODICE	€	NOTES - NOTE
CBR 600 RR	2007	2025	H018	539,00	F/N/R/W
CBR 1000 RR-R Fireblade / SP "Track use"	2020	2025	H015	591,00	N/R/O/P/W
CBR 1000 RR-R Fireblade / SP	2020	2025	H016	631,00	N/R/P/W
CBR 650 R/CB 650 R/F without Quickshifter - senza QS	2014	2025	H012	449,00	N/R/W



HONDA CBR 600 RR - cod. H018



HONDA CBR 650 R/CB 650 R/F - cod. H012



HONDA CBR1000RR-R FIREBLADE - cod. H015



Honda CBR 600 RR (2007/ 2025)
code H018 + accessories RC03_BL

KAWASAKI

MODEL - MODELLO	FROM - DAL	TO - AL	CODE - CODICE	€	NOTES - NOTE
ZX-4R/RR	2023	2025	K022	699,00	N/R/F/T/W
ZX-6R (PRO)	2020	2025	K024	635,00	N/R/F/W
ZX-10R	2016	2025	K021	699,00	N/R/F/T/W
Z 900	2017	2025	K023B	471,00	A/N/R/F/P/W



KAWASAKI ZX-10R - cod. K021

KTM

MODEL - MODELLO	FROM - DAL	TO - AL	CODE - CODICE	€	NOTES - NOTE
790 / 890 Duke / 890 Duke R	2018	2023	KT04	549,00	N/R/P/T/W
1290 Super Duke R	2020	2023	KT06	561,00	N/R/T/W
1390 Super Duke R	2024	2025	KT06	561,00	N/R/T/W



790 / 890 Duke / 890 Duke R - cod. KT04

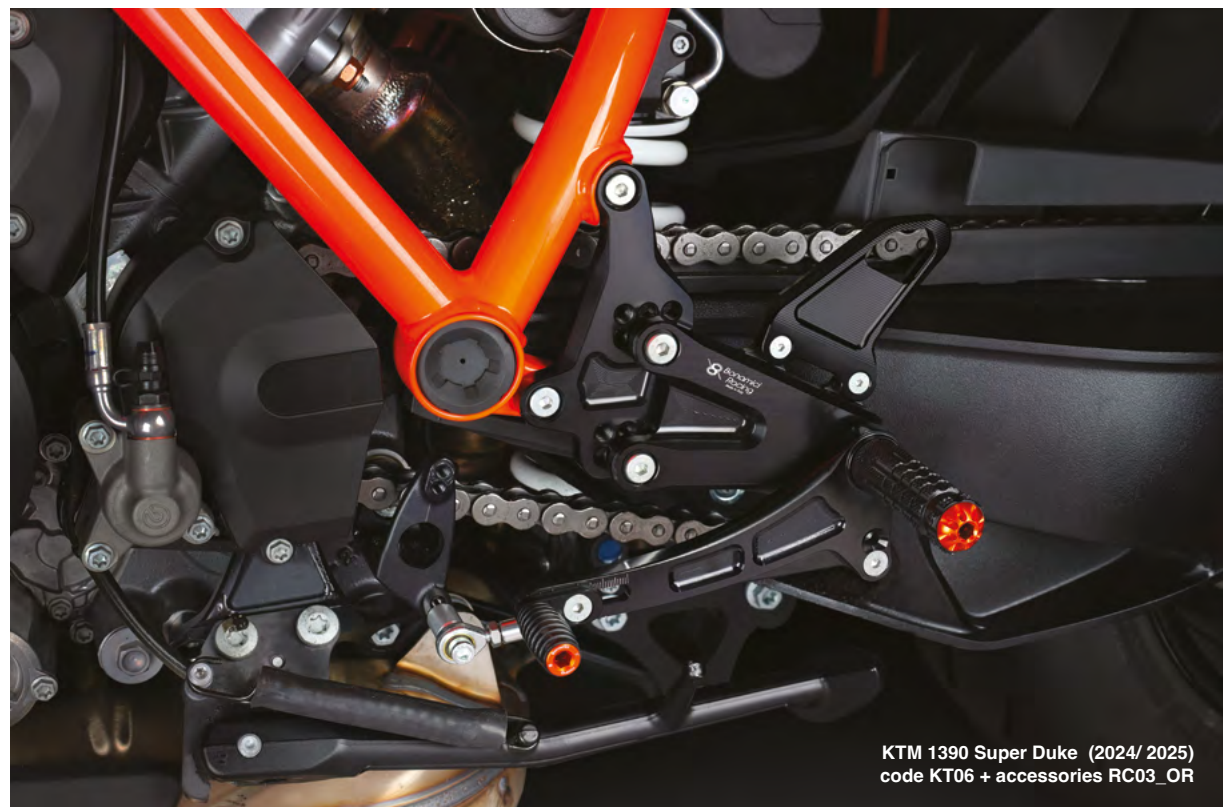

KTM 1390 Super Duke (2024/2025)
code KT06 + accessories RC03_OR



1390 Super Duke R (2024-2024)- cod. KT06

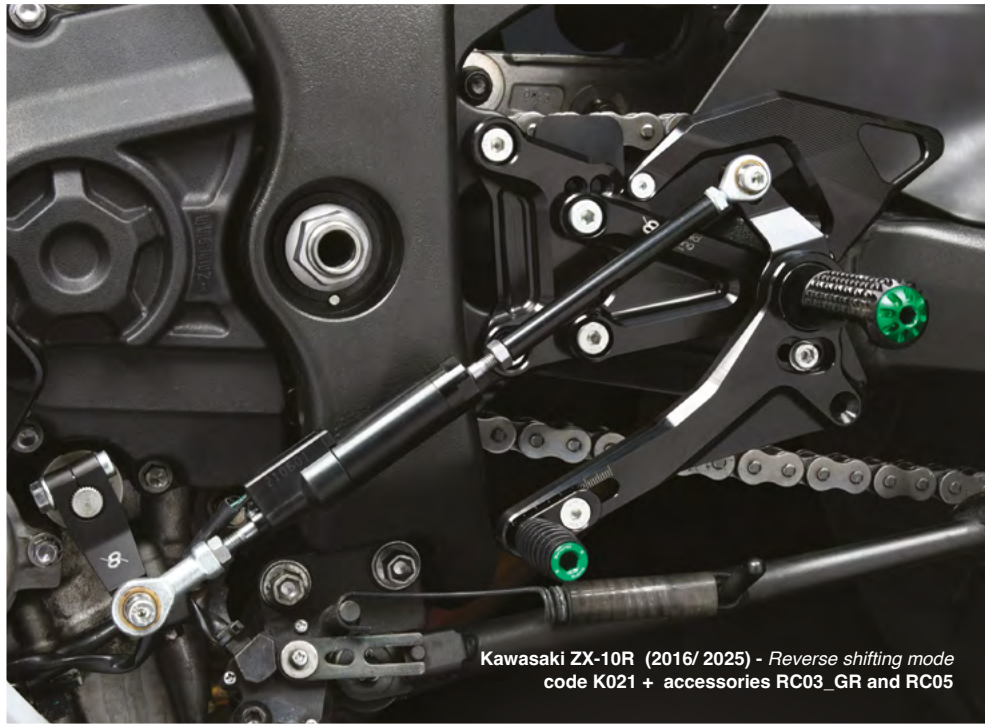

Kawasaki ZX-10R (2016/ 2025) - Reverse shifting mode
code K021 + accessories RC03_GR and RC05



Kawasaki ZX-10R (2016/ 2025) - Normal shifting mode
code K021 + accessories RC03_GR and RC05

Triumph Street Triple 765 Moto2
code TH07



SUZUKI

MODEL - MODELLO	FROM - DAL	TO - AL	CODE - CODICE	€	NOTES - NOTE
GSX-8S/8R	2023	2025	S014	501,00	N/R/W
GSX-R 1000	2017	2025	S011	531,00	N/R/P/W

TRIUMPH

MODEL - MODELLO	FROM - DAL	TO - AL	CODE - CODICE	€	NOTES - NOTE
Street Triple S/R/RS 765	2017	2022	TH06	584,00	F/N/L/P/R/W
Street Triple 765 R/RS/Moto 2	2023	2025	TH09	584,00	F/N/P/R/T/W
Speed Triple 1200 RS - (RX M.Y. 2025/2025)	2021	2025	TH08	596,00	N/R/T/W
Speed Triple 1200 RR	2022	2025	TH07	596,00	N/R/T/W



● SUZUKI GSX-R 1000 - cod. S011



● SUZUKI GSX-8S/8R - cod. S014



● TRIUMPH SPEED TRIPLE 1200 RR - cod. TH07



MODEL - MODELLO	FROM - DAL	TO - AL	CODE - CODICE	€	NOTES - NOTE
YZF R3 / R25	2015	2025	Y012	430,00	F/N/R/P/W
YZF R3 / R25 ** Raised +40 mm compared to Y012	2015	2025	Y012_40	430,00	F/N/R/P/W
YZF R6	2006	2016	Y005	449,00	N/R/P/W
YZF R6	2017	2025	Y013	501,00	N/R/W
YZF R1/R1M	2015	2025	Y011	571,00	N/R/P/W
YZF R1/R1M Rearsetwith bracket for OEM Akrapovic exhaust Pedana con staffa per scarico Akrapovic OEM	2015	2022	Y011A	662,00	N/R/P/W
YZF R7	2021	2025	Y015	501,00	N/R/T/W
MT-07/FZ07	2014	2020	Y010	449,00	N/R/P/W
MT-09	2021	2025	Y016	501,00	F/N/R/T/W
NEW YZF R9	2025	2025	Y017	600,00	N/R/T/W

* Available only on specific request - * Disponibili solo su specifica richiesta

** The brake hose needs to be replaced - ** È necessario sostituire il tubo freno

**WARNING
ATTENZIONE**

- Before use, make sure that all screws are tightened with care. Use light strength thread-locker.
- The assistance of professional staff is necessary for all the parts which require installation.
- All Bonamici Racing products are made for racing use only (not for street use).
- After any kind of impact, it is obligatory to replace the affected parts.
- It is obligatory to check the tightened of the screws after every ride session.
- Prima dell'uso, assicurarsi che tutte le viti siano serrate con cura. Usa un frenafili.
- Per tutte le parti che necessitano di installazione è necessaria l'assistenza di personale qualificato.
- Tutti i prodotti Bonamici Racing sono realizzati esclusivamente per uso agonistico (non per uso stradale).
- Dopo ogni tipo di urto è obbligatorio sostituire le parti interessate.
- È obbligatorio controllare il serraggio delle viti dopo ogni sessione di guida.

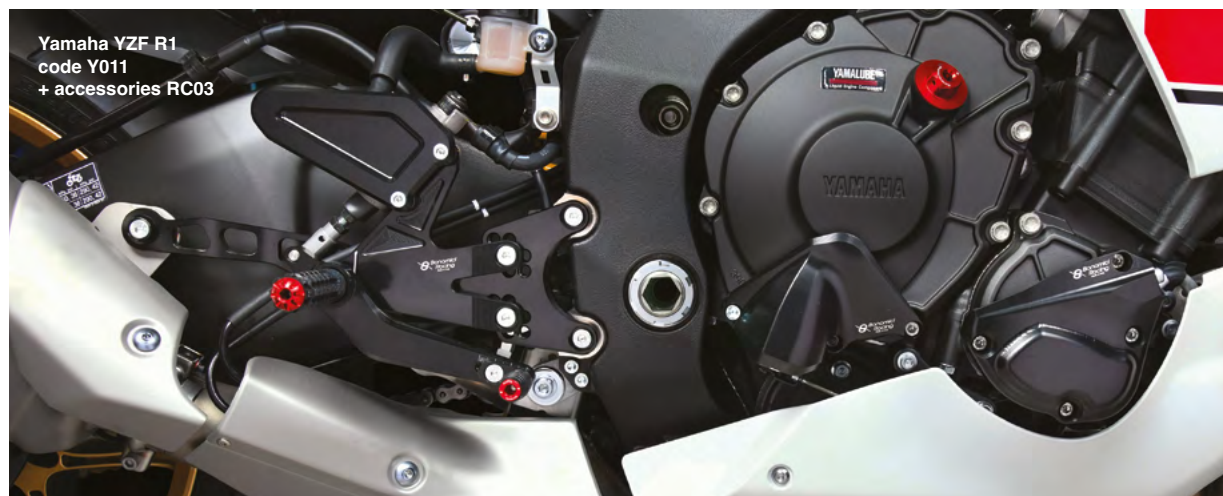

YAMAHA YZF R1/R1M - cod. Y011



YAMAHA YZF R7 - cod. Y015



YAMAHA YZF R9 - cod. Y017

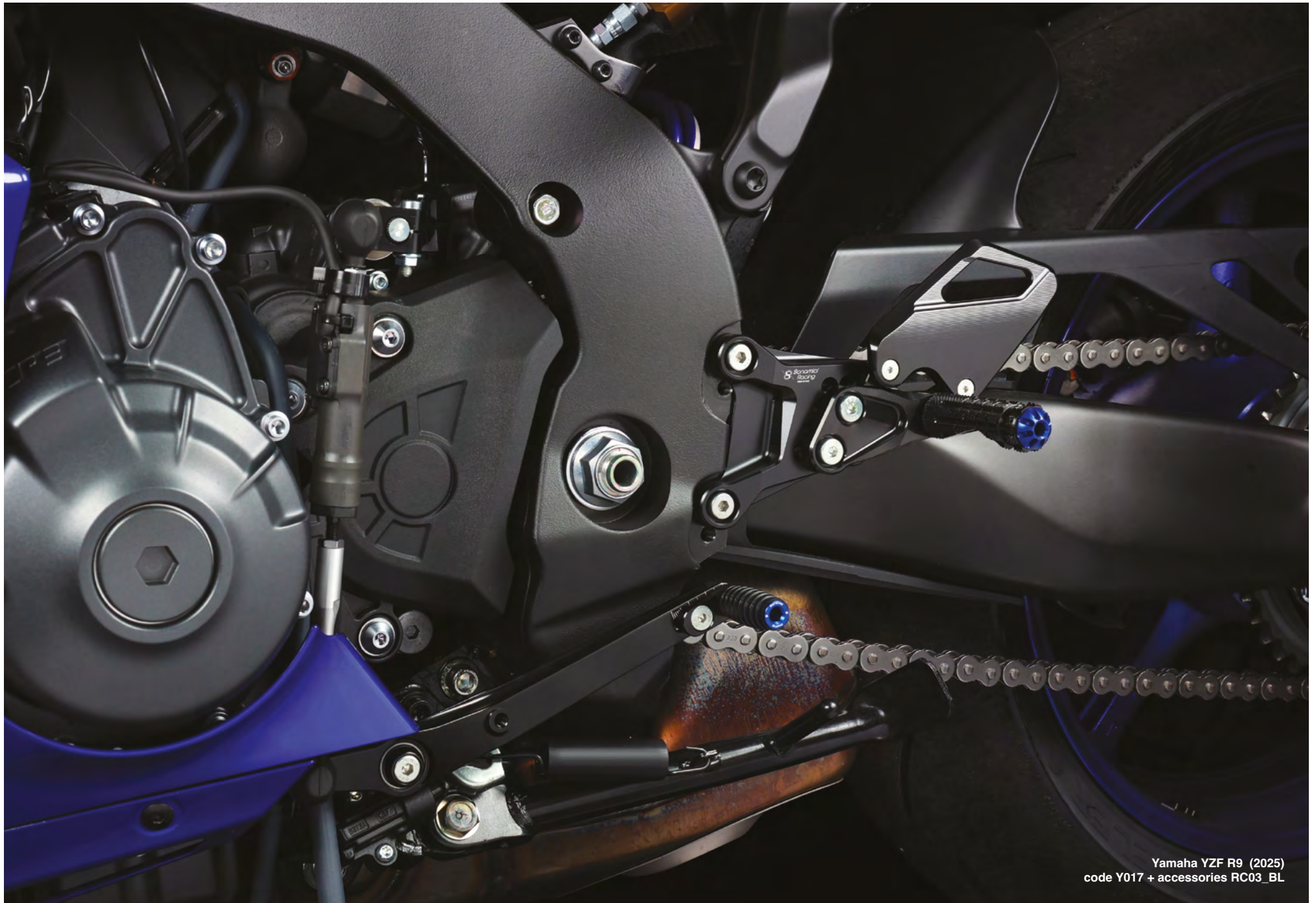

Yamaha YZF R9 (2025)
code Y017 + accessories RC03_BL

REARSETS ACCESSORIES - ACCESSORI PEDANE

The full range of Bonamici Racing rearsets is supplied in the "Standard" version with black color, aluminum heelplates, fixed foot pegs and toe pegs. At the time of purchase it is possible to request the rearsets in different colors and with laser engraving, the rest of the accessories can all be purchased separately. Pay attention to the "notes" on the rearsets page.

L'intera gamma pedane Bonamici Racing è fornita nella versione "Standard" con colore nero, paratacchi in alluminio, poggia piedi e puntalini fissi. Al momento dell'acquisto è possibile richiedere la pedana in diversi colori e con incisione laser, il resto degli accessori sono acquistabili tutti separatamente. Fare attenzione alle "note" nella pagina pedane.

DESCRIPTION - DESCRIZIONE	CODE - CODICE	€	NOTES - NOTE
Pair of racing foot pegs - Coppia di poggia piedi racing (82mm+82mm)	RC05_LL	136,00	3
Pair of racing foot pegs - Coppia di poggia piedi racing (69mm+82mm)	RC05_SL	136,00	3
Pair of racing foot pegs - Coppia di poggia piedi racing (69mm+69mm)	RC05_SS	136,00	3
Pair of folding foot pegs - Coppia di poggia piedi chiudibili	KPC	136,00	3/4
Pair of standard folding toe pegs - Coppia di puntalini chiudibili standard	RC02	97,00	5
Pair of knurled folding toe pegs - Coppia di puntalini chiudibili godronati	RC02G	128,00	5
Pair of striped folding toe pegs - Coppia di puntalini chiudibili rigati	RC02R	128,00	5
Pair of carbon heel plates - Coppia di paratacchi in carbonio	RC08	84,00	1
Hydrostop M10 x 1 - Interruttore stop idraulico M10 x 1	HD100	29,00	2
Hydrostop M10 x 1,25 - Interruttore stop idraulico M10 x 1,25	HD125	29,00	2
Wired hydrostop for Ducati - Interruttore stop cablato per Ducati	HDC01	48,00	-
Wired hydrostop for Ducati Streetfighter V4/V2 - Interruttore stop cablato per Ducati Streetfighter V4/V2	HDC02	48,00	-
Pairs of colored aluminum caps and toe pegs (blue) - Coppie di tappi e puntalini in alluminio colorati (blu)	RC03_BL	62,00	-
Pairs of colored aluminum caps and toe pegs (green) - Coppie di tappi e puntalini in alluminio colorati (verde)	RC03_GR	62,00	-
Pairs of colored aluminum caps and toe pegs (gold) - Coppie di tappi e puntalini in alluminio colorati (oro)	RC03_GO	62,00	-
Pairs of colored aluminum caps and toe pegs (orange) - Coppie di tappi e puntalini in alluminio colorati (arancione)	RC03_OR	62,00	-
Pairs of colored aluminum caps and toe pegs (red) - Coppie di tappi e puntalini in alluminio colorati (rosso)	RC03_RE	62,00	-
Pairs of colored aluminum caps and toe pegs (silver) - Coppie di tappi e puntalini in alluminio colorati (argento)	RC03_SI	62,00	-
Pairs of colored aluminum caps and toe pegs (bronze) - Coppie di tappi e puntalini in alluminio colorati (bronzo)	RC03_BR	62,00	-
Aluminium stand for rearsets - Espositore pedane in Alluminio	EX01	50,00	-

CUSTOMIZATION - PERSONALIZZAZIONE

• By purchasing a new Rearsetkit it is possible to request the following customization services

• Acquistando una nuova pedana è possibile richiedere i seguenti accessori

DESCRIPTION - DESCRIZIONE	CODE - CODICE	€
Laser engravings (one pair) - Incisioni laser (coppia)	KLS2	30,00

NOTES - NOTE

- 1: To verify the possibility in the Rearsetsnotes ("P")
Verificare la possibilità nelle note delle pedane ("P")
- 2: Available only for the OEM switch stop with two cables
Disponibile solo per impianti stop originali a due cavi
- 3: Black foot pegs caps
Tappi poggia piedi di colore nero
- 4: For the complete code see table of folding foot pegs on page. 24 and page 25
Per il codice completo vedere tabella poggia piedi chiudibili a pag. 24 e pag. 25
- 5: Available only in black colour
Disponibili solo di colore nero

WARNING ATTENZIONE

- It's possible to find all the spare parts on the specific catalog
- È possibile trovare tutte le parti di ricambio sul catalogo specifico

Folding foot pegs code Codici poggia piedi chiudibili



Rearsets code Codice pedana	Models Modello	Foot pegs code Codice poggia piedi	€	
APRILIA	A005S	RSV4 APRC - Tuono V4 APRC (street) ('17/'24)	KPC01	136,00
	A005SR	RSV4 APRC - Tuono V4 APRC (race) ('17/'24)	KPC01	136,00
	A006	RS660 ('20/'25)	KPC01	136,00

Rearsets code Codice pedana	Models Modello	Foot pegs code Codice poggia piedi	€	
BMW	B005	S 1000 RR ('15/'18)	KPC01	136,00
	B007	S 1000 RR ('21/'25)- M 1000 RR ('21/'25)	KPC03	136,00
	B008	S 1000 R - M 1000 R ('21/'25)	KPC03	136,00

Rearsets code Codice pedana	Models Modello	Foot pegs code Codice poggia piedi	€	
DUCATI	DV2	899/1199/1299 Panigale/V2 ('12/'24)	KPC02	136,00
	DV4	Panigale V4 ('18/'24)	KPC02	136,00
	D001	Panigale V4 (2025)	KPC04	136,00
	D002	Streetfighter V4 (2025)	KPC04	136,00
	DSTR3	Streetfighter V2 ('22/'24)	KPC02	136,00
	DSTR2	Streetfighter V4 ('20/'24)	KPC02	136,00

Folding foot pegs code - Codici poggiapiedi chiudibili

Rearsets code Codice pedana	Models Modello	Foot pegs code Codice poggiapiedi	€
HONDA	H012	CBR 650 R/CB 650 R ('14/'25)	KPC01 136,00
	H015	CBR 1000 RR-R Fireblade (track use) ('20/'25)	KPC01 136,00
	H016	CBR 1000 RR-R Fireblade ('20/'25)	KPC01 136,00
	H018	CBR 600 RR Fireblad ('07/'25)	KPC05 136,00

Rearsets code Codice pedana	Models Modello	Foot pegs code Codice poggiapiedi	€
TRIUMPH	TH06	Street Triple 765/800 ('17/'22)	KPC01 136,00
	TH07	Speed Triple 1200 RR ('22/'25)	KPC01 136,00
	TH08	Speed Triple 1200 RS ('21/'25)	KPC01 136,00
	TH09	Street Triple 765 R/RS/Moto 2 ('23/'25)	KPC01 136,00

Rearsets code Codice pedana	Models Modello	Foot pegs code Codice poggiapiedi	€
KAWASAKI	K021	ZX-10R ('21/'25)	KPC02 136,00
	K022	ZX-4R/RR ('23/'25)	KPC02 136,00
	K023B	Z 900 ('17/'25)	KPC01 136,00
	K024	ZX-6R PRO ('20/'25)	KPC02 136,00

Rearsets code Codice pedana	Models Modello	Foot pegs code Codice poggiapiedi	€
YAMAHA	Y005	YZF R6 ('06/'16)	KPC01 136,00
	Y010	MT-07/FZ07 ('14/'20)	KPC01 136,00
	Y011	YZF R1/R1M ('15/'25)	KPC01 136,00
	Y012	YZF R3 ('15/'25)	KPC01 136,00
	Y013	YZF R6 ('17/'25)	KPC01 136,00
	Y015	YZF R7 ('21/'25)	KPC05 136,00
	Y016	MT-09 ('21/'25)	KPC05 136,00
	Y017	YZF R9 ('25/'25)	KPC05 136,00

Rearsets code Codice pedana	Models Modello	Foot pegs code Codice poggiapiedi	€
KTM	KT04	Duke 790/890 ('18/'23)	KPC02 136,00
	KT06	1290 Super Duke R ('20/'23)	KPC06 136,00
	KT06	1390 Super Duke R ('24/'25)	KPC06 136,00

Rearsets code Codice pedana	Models Modello	Foot pegs code Codice poggiapiedi	€
SUZUKI	S011	GSX-R 1000 ('17/'25)	KPC01 136,00
	S014	GSX-8S/8R ('23/'25)	KPC05 136,00



WorldSBK GRT Yamaha rider Remy Gardner shows Bonamici Racing rearset



Racing foot pegs / Poggiapiiedi racing - cod. RC05 **Folding foot pegs** / poggiapiiedi chiudibili - cod. KPC



Standard folding toe pegs
Puntalini chiudibili standard cod. RC02 **Knurled folding toe pegs**
Puntalini chiudibili godronati cod. RC02G **Striped folding toe pegs**
Puntalini chiudibili rigati - cod. RC02R

GEAR SPACER SUPPORT - SUPPORTO DISTANZIALE CAMBIO

A spacer that enables the installation of rearsets without the need for a side stand.

Distanziale che consente l'installazione delle pedane senza il cavalletto laterale.

MODEL - MODELLO	FROM - DAL	TO - AL	CODE - CODICE	€
Honda CBR 600 RR	2024	2025	DC_042D	70,00
Honda CBR 1000RR-R	2020	2025	DC_040B	108,00
Suzuki GSX-8S/8R	2023	2025	DC_043B	94,00
BMW S 1000 RR	2019	2025	DC_039B	95,00
BMW M 1000 RR	2021	2025	DC_039B	95,00
BMW S 1000 R	2021	2025	DC_039B	95,00
Yamaha YZF R6	2017	2025	DC_037B	95,00
NEW Yamaha YZF R9	2025	2025	DC_039C	105,00



Pairs of caps and standard toe pegs coloured
Coppie di tappi e puntalini standard colorati - cod. RC03



Laser engravings (one pair)
Incisioni laser (coppia) - cod. KLS2



Hydrostop M10 x 1
Interruttore stop idraulico M10 x 1 - cod. HD100

Hydrostop M10 x 1,25
Interruttore stop idraulico M10 x 1,25 - cod. HD125



Wired hydrostop for Ducati
Interruttore stop cablato per Ducati - cod. HDC01



Wired hydrostop for Ducati Streetfighter V4
Interruttore stop cablato per Ducati Streetfighter V4 - cod. HDC02

• The heelplates pictured is for illustrative purposes only
• I paratacchi nella foto sono solo a scopo illustrativo



Pair of carbon heel plates
Coppia di paratacchi in carbonio - cod. RC08

ENGINE PROTECTIONS - PROTEZIONI MOTORE



The Bonamici Racing engine protection comes from the collaboration with the teams involved in the World Superbike Championship.

Made by high-strength aluminum alloy, machined from solid with CNC technology and finished with black anodizing, the engine cover kit perfectly protects the carter during falls and slides. It is composed by two or three elements, depending by the model, who protect the carter on both sides of the bike.

The engine protections can be purchased both in kit and individually and it's possible to customize them in other colors or with laser engraving according to customer specifications.

Bonamici Racing boasts the widest range of aluminum engine protections dedicated to the major sport-bikes on the market.

Dalla collaborazione con i team che corrono nel mondiale superbike, nascono le protezioni carter motore della Bonamici Racing.

In lega d'alluminio ad alta resistenza, lavorato dal pieno con tecnologia CNC e rifinito con anodizzazione nera, il kit protegge perfettamente i carter della moto in caso di eventuali cadute.

E' composto da due o tre elementi che proteggono i carter da entrambi i lati della moto. Le protezioni carter sono disponibili sia in kit che singolarmente ed è possibile personalizzarle in altri colori o con incisione laser su specifica del cliente.

Bonamici Racing vanta la più ampia gamma di protezioni motore in alluminio dedicate alle maggiori moto sportive del mercato.



MODEL - MODELLO	DESCRIPTION - DESCRIZIONE	FROM - DAL	TO - AL	CODE - CODICE	€
RSV4 - RSV4 <i>FACTORY</i> - Tuono V4	right side - lato DX	2021	2024	CP001	253,00
RSV4 - RSV4 <i>FACTORY</i> - Tuono V4	left side - lato SX	2021	2024	CP106	124,00
RSV4 - RSV4 <i>FACTORY</i> - Tuono V4	full kit - kit completo	2021	2024	CP107	377,00
RS 660 - Tuono 660 - Tuareg 660	right side - lato DX	2020	2025	CP111	222,00
RS 660 - Tuono 660 - Tuareg 660	left side - lato SX	2020	2025	CP112	144,00
RS 660 - Tuono 660 - Tuareg 660	left side (water pump) lato SX (pompa acqua)	2020	2025	CP113	118,00
RS 660 - Tuono 660 - Tuareg 660	full kit - kit completo	2020	2025	CP114	481,00



APRILIA RSV4 Factory (2021/2024)
full kit - kit completo - cod. CP107



Aprilia RS660
right side - code CP111



APRILIA RS 660 (2020/2025)
full kit - kit completo - cod. CP114



Aprilia RS660
left side - code CP112

* Available only on specific request - * Disponibili solo su specifica richiesta

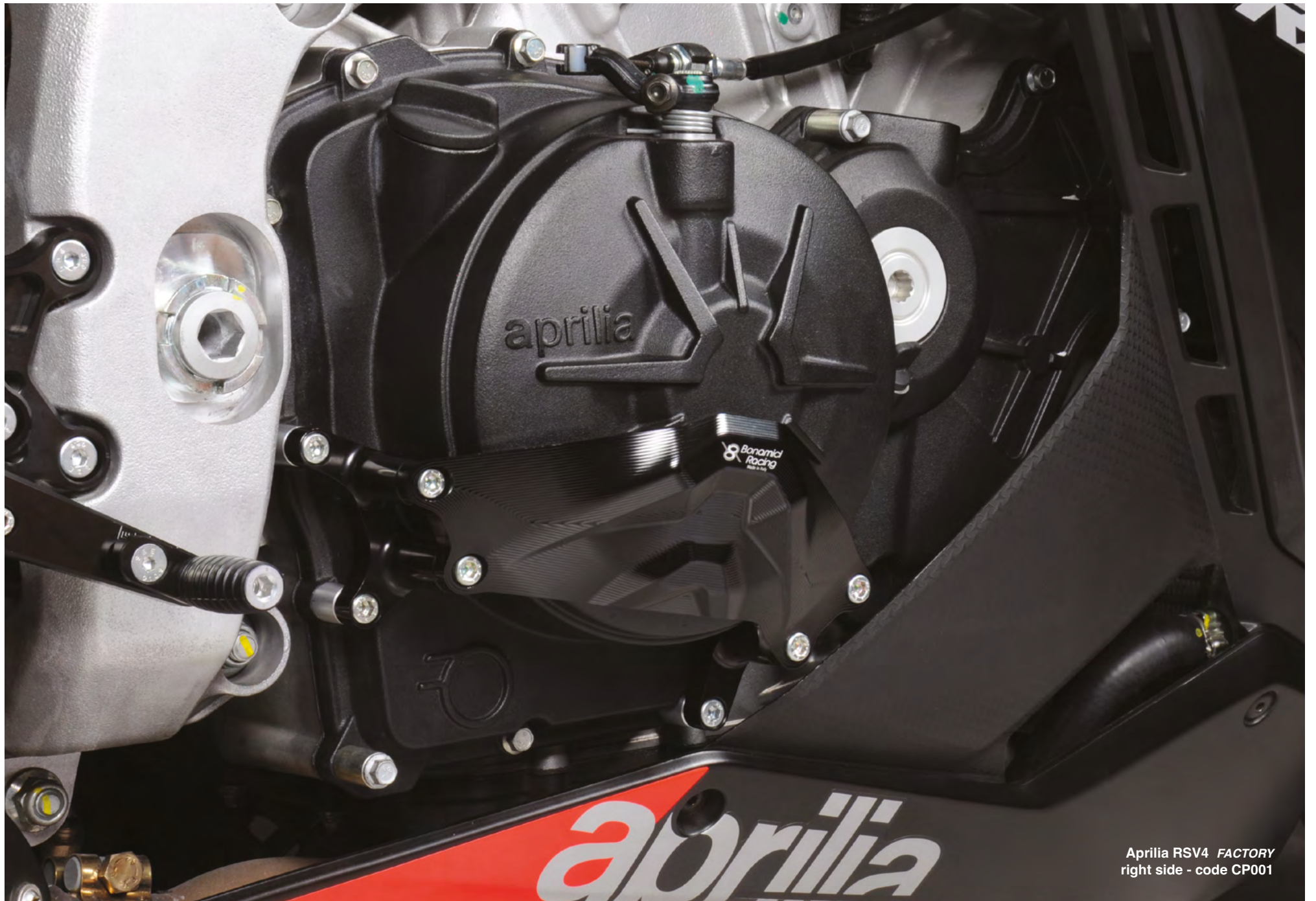

Aprilia RSV4 *FACTORY*
right side - code CP001

MODEL - MODELLO	DESCRIPTION - DESCRIZIONE	FROM - DAL	TO - AL	CODE - CODICE	€
S 1000 RR - M 1000 RR	right side (pick-up) - lato DX (pick-up)	2019	2025	CP084C	156,00
S 1000 RR - M 1000 RR	right side (clutch) - lato DX (frizione)	2019	2025	CP085B	130,00
S 1000 RR - M 1000 RR	left side "racing" (2pcs.) lato SX "racing" (2pz.)	2019	2025	CP082B	194,00
S 1000 RR - M 1000 RR	left side (water pump) lato SX (pompa acqua)	2019	2025	CP083	92,00
S 1000 RR - M 1000 RR	full kit "racing" (5pcs.) kit compl. "racing" (5pz.)	2019	2025	CP086B	571,00
M 1000 RR	right side (pick-up) - lato DX (pick-up)	2021	2024	CP084C	156,00
M 1000 RR	right side (clutch) - lato DX (frizione)	2021	2024	CP085B	130,00
M 1000 RR	left side "racing" (2pcs.) lato SX "racing" (2pz.)	2021	2024	CP082B	194,00
M 1000 RR	left side (water pump) lato SX (pompa acqua)	2021	2024	CP083	92,00
M 1000 RR	full kit "racing" (5pcs.) kit compl. "racing" (5pz.)	2021	2024	CP086B	571,00
S 1000 R - M 1000 R	right side (pick-up) - lato DX (pick-up)	2021	2025	CP084C	156,00
S 1000 R - M 1000 R	right side (clutch) - lato DX (frizione)	2021	2025	CP085B	130,00
S 1000 R - M 1000 R	left side "racing" (2pcs.) lato SX "racing" (2pz.)	2021	2025	CP082B	194,00
S 1000 R - M 1000 R	left side (water pump) lato SX (pompa acqua)	2021	2025	CP083	92,00
S 1000 R - M 1000 R	full kit "racing" (5pcs.) kit compl. "racing" (5pz.)	2021	2025	CP086B	571,00
S 1000 XR	right side (pick-up) - lato DX (pick-up)	2020	2025	CP084C	156,00
S 1000 XR	right side (clutch) - lato DX (frizione)	2020	2025	CP085B	130,00
S 1000 XR	left side - lato SX	2020	2025	CP115	118,00
S 1000 XR	left side (water pump) lato SX (pompa acqua)	2020	2025	CP083	92,00
S 1000 XR	full kit (4pcs.) kit completo (4pz.)	2020	2025	CP116	494,00
M 1000 XR	right side (pick-up) - lato DX (pick-up)	2024	2025	CP084C	156,00
M 1000 XR	right side (clutch) - lato DX (frizione)	2024	2025	CP085B	130,00
M 1000 XR	left side "racing" (2pcs.) lato SX "racing" (2pz.)	2024	2025	CP082B	194,00
M 1000 XR	left side (water pump) lato SX (pompa acqua)	2024	2025	CP083	92,00
M 1000 XR	full kit "racing" (5pcs.) kit compl. "racing" (5pz.)	2024	2025	CP086B	571,00

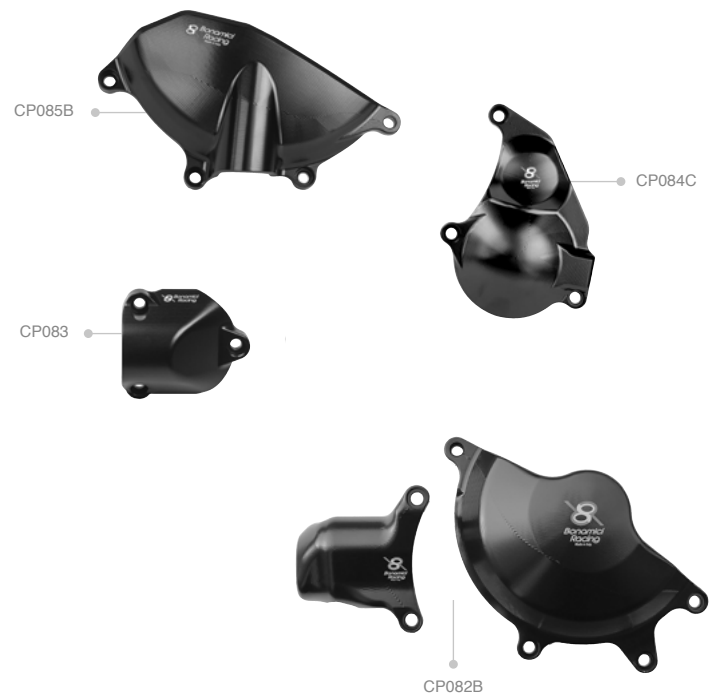

BMW S 1000 RR (2019 / 2025)
BMW M 1000 RR (2021 / 2024)
BMW S 1000 R (2021 / 2025)
BMW M 1000 XR (2024 / 2025)
full kit (5 pcs.) - kit completo (5 pz.) - Cod.CP086B



Left side "racing" (2pcs.)
Cod.CP082B

CP086B composed by 5 pieces including the new protection for Crankshaft Sensor (CP082B), the latest invention of Bonamici Racing, especially useful for use on track.

CP086B composto da 5 pezzi tra cui la nuova protezione per Sensore Albero Motore (CP082B), ultima invenzione di Bonamici Racing, particolarmente utile per l'utilizzo in pista.

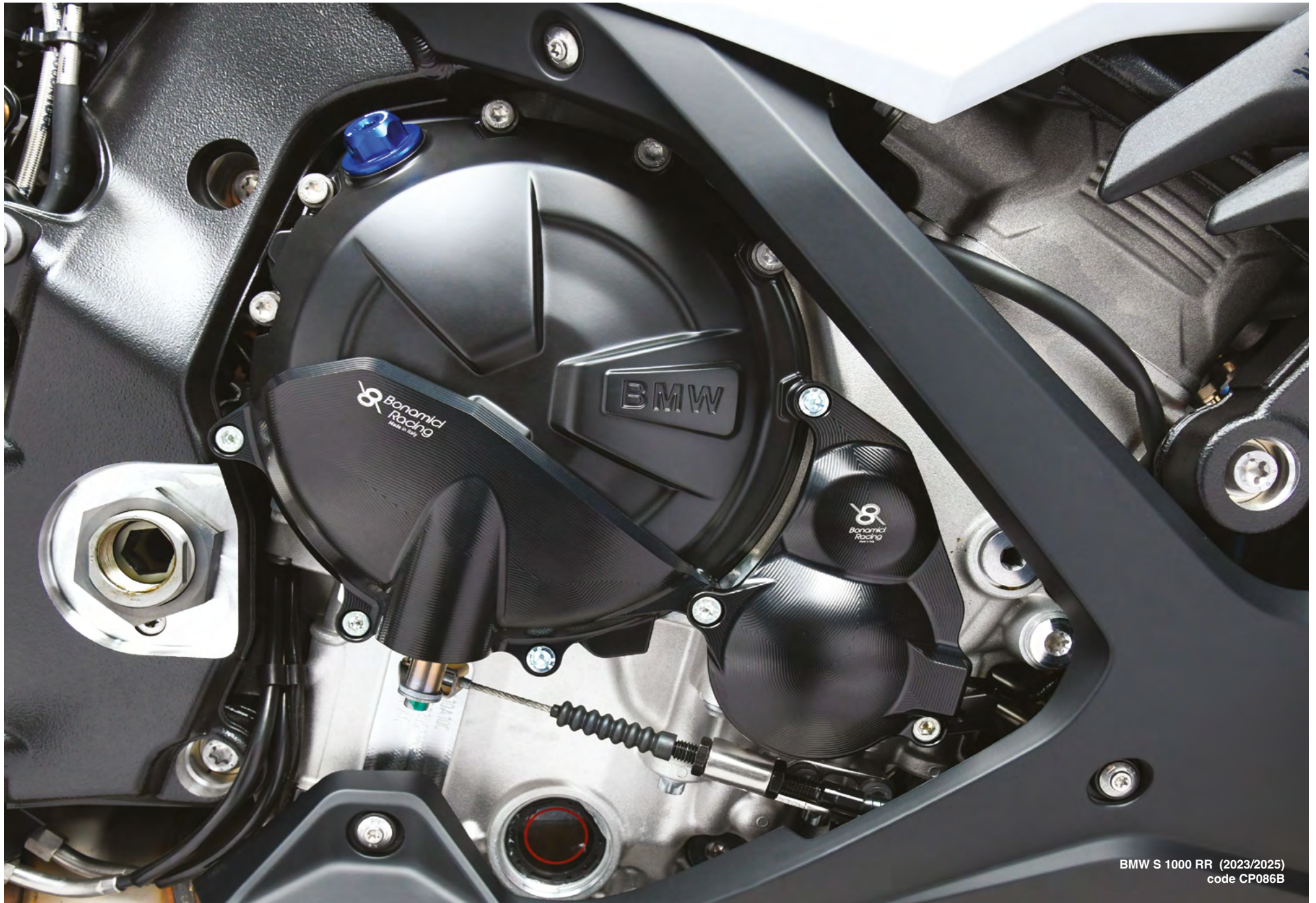

BMW S 1000 RR (2023/2025)
code CP086B

DUCATI

MODEL - MODELLO	DESCRIPTION - DESCRIZIONE	FROM - DAL	TO - AL	CODE - CODICE	€
959 Panigale	right side - lato DX	2016	2018	CP007	207,00
959 Panigale	left side - lato SX	2016	2018	CP008B	183,00
959 Panigale	full kit - kit completo	2016	2018	CP009B	389,00
1199/1299 Panigale	right side - lato DX	2012	2018	CP007	207,00
1199/1299 Panigale	left side - lato SX	2012	2018	CP008A	183,00
1199/1299 Panigale	full kit - kit completo	2012	2018	CP009A	389,00
Panigale V4/V4S	right side - lato DX	2018	2024	CP079	208,00
Panigale V4/V4S	left side - lato SX	2018	2024	CP080	169,00
Panigale V4/V4S	full kit - kit completo	2018	2024	CP081	377,00
Panigale V4/V4S	right side - lato DX	2025	2025	CP125	208,00
Panigale V4/V4S	left side - lato SX	2025	2025	CP126	169,00
Panigale V4/V4S	full kit - kit completo	2025	2025	CP127	377,00
Panigale V4R	right side - lato DX	2018	2024	CP079B	208,00
Panigale V4R	left side - lato SX	2018	2024	CP080	169,00
Panigale V4R	full kit - kit completo	2018	2024	CP081B	377,00
Panigale V2	right side - lato DX	2020	2024	CP007	207,00
Panigale V2	left side - lato SX	2020	2024	CP104	183,00
Panigale V2	full kit - kit completo	2020	2024	CP105	389,00
Panigale V2 "Racing" *	right side - lato DX	2020	2024	CP120	252,00
Panigale V2 "Racing" *	left side - lato SX	2020	2024	CP121	221,00
Panigale V2 "Racing" *	full kit - kit completo	2020	2024	CP122	473,00
Streetfighter V4/V4S	right side - lato DX	2020	2022	CP101	286,00
Streetfighter V4/V4S	left side - lato SX	2020	2022	CP102	169,00
Streetfighter V4/V4S	full kit - kit completo	2020	2022	CP103	455,00
Streetfighter V4/V4S	right side - lato DX	2023	2024	CP079	208,00
Streetfighter V4/V4S	left side - lato SX	2023	2024	CP080	169,00
Streetfighter V4/V4S	full kit - kit completo	2023	2024	CP081	377,00
Streetfighter V4/V4S	right side - lato DX	2025	2025	CP125	208,00
Streetfighter V4/V4S	left side - lato SX	2025	2025	CP128	169,00
Streetfighter V4/V4S	full kit - kit completo	2025	2025	CP129	377,00

* Installation is possible only on racing racing fairings - * L'installazione è possibile solo su carene racing



Ducati Panigale V4 (2025)
right side - code CP125



DUCATI PANIGALE V4 / V4S - full kit - kit completo - cod. CP127



STREETFIGHTER V4/V4S - full kit - kit completo (2020-2022) - cod. CP103



DUCATI 1199 / 1299 PANIGALE - full kit - kit completo - cod. CP009A



Honda CBR1000RR-R Fireblade (2020/2025)
code CP100



Honda CBR1000RR-R (2020/ 2025)
code CP100



HONDA

PRICES WITHOUT VAT - PREZZI IVA ESCLUSA

MODEL - MODELLO	DESCRIPTION - DESCRIZIONE	FROM - DAL	TO - AL	CODE - CODICE	€
CBR 1000RR-R Fireblade	right side (distrib.) - lato DX (distrib.)	2020	2025	CP097	118,00
CBR 1000RR-R Fireblade	right side (clutch) - lato DX (frizione)	2020	2025	CP098	195,00
CBR 1000RR-R Fireblade	left side - lato SX	2020	2025	CP099	169,00
CBR 1000RR-R Fireblade	full kit - kit completo	2020	2025	CP100	481,00

HONDA CBR1000RR-R FIREBLADE - full kit - kit completo - cod. CP100

KAWASAKI

MODEL - MODELLO	DESCRIPTION - DESCRIZIONE	FROM - DAL	TO - AL	CODE - CODICE	€
ZX-10R	right side - lato DX	2011	2025	CP010	150,00
ZX-10R	left side - lato SX	2011	2025	CP011	124,00
ZX-10R	full kit - kit completo	2011	2025	CP012	273,00

KTM

MODEL - MODELLO	DESCRIPTION - DESCRIZIONE	FROM - DAL	TO - AL	CODE - CODICE	€
890 Duke / 890 Duke R	right side (water pump) lato DX (pompa acqua.) *	2020	2023	CP090	99,00
890 Duke / 890 Duke R	right side (clutch) - lato DX (frizione) *	2020	2023	CP091B	130,00
890 Duke / 890 Duke R	left side - lato SX *	2020	2023	CP092B	150,00
890 Duke / 890 Duke R	full kit - kit completo *	2020	2023	CP093B	377,00
1290 Super Duke	right side - lato DX	2013	2019	CP058	150,00
1290 Super Duke	left side - lato SX	2013	2019	CP059	195,00
1290 Super Duke	full kit - kit completo	2013	2019	CP060	344,00
1290 Super Duke R	right side - lato DX	2020	2023	CP058	150,00
1290 Super Duke R	left side - lato SX	2020	2023	CP059	195,00
1290 Super Duke R	full kit - kit completo	2020	2023	CP060	344,00
1390 Super Duke R	right side - lato DX	2024	2025	CP123	161,00
1390 Super Duke R	left side - lato SX	2024	2025	CP059	195,00
1390 Super Duke R	full kit - kit completo	2024	2025	CP124	355,00

(*) Availability is limited; this product will be supplied while stocks last - (*) Disponibilità limitata: il prodotto sarà fornito fino ad esaurimento scorte.



KTM 1390 Super Duke (2024/ 2025) - code CP123



KAWASAKI ZX-10R - full kit - kit completo - cod. CP012



KTM 890 DUKE - full kit - kit completo - cod. CP093B



KTM 1390 Super Duke - full kit - kit completo - cod. CP124



Kawasaki ZX-10R (2011/ 2025)
code CP012

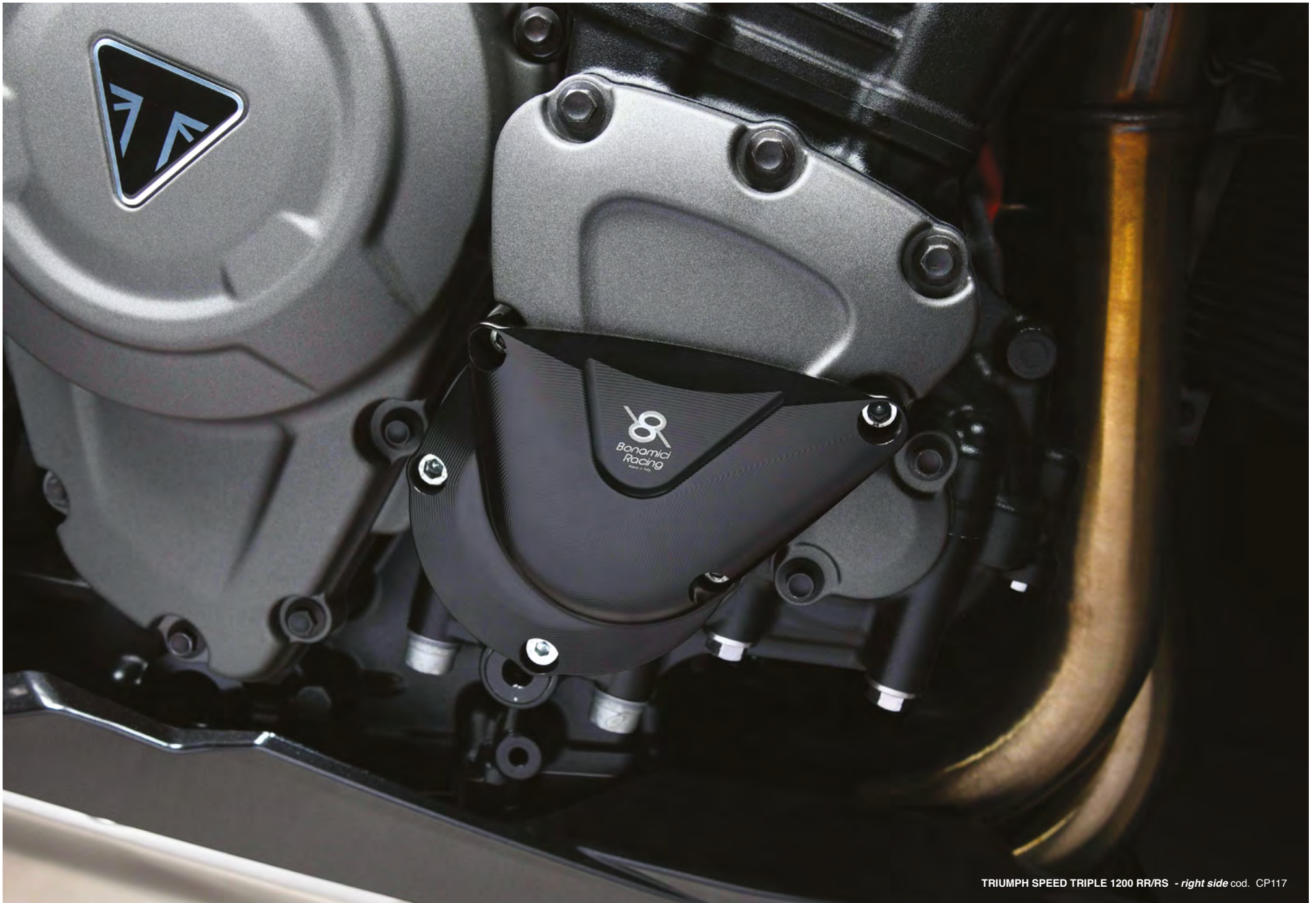

TRIUMPH SPEED TRIPLE 1200 RR/RS - right side cod. CP117

SUZUKI



SUZUKI GSX-R 1000 - full kit - kit completo - cod. CP070

MODEL - MODELLO	DESCRIPTION - DESCRIZIONE	FROM - DAL	TO - AL	CODE - CODICE	€
GSX-R 1000	right side (distrib.) - lato DX (distrib.)	2017	2025	CP067	105,00
GSX-R 1000	right side (clutch) - lato DX (frizione)	2017	2025	CP068	144,00
GSX-R 1000	left side - lato SX	2017	2025	CP069	169,00
GSX-R 1000	full kit - kit completo	2017	2025	CP070	416,00

TRIUMPH



TRIUMPH SEEP TRIPLE 1200 RR/RS - full kit - kit completo - cod. CP119 **NEW**

MODEL - MODELLO	DESCRIPTION - DESCRIZIONE	FROM - DAL	TO - AL	CODE - CODICE	€
Street Triple 765 S/R/RS	right side (distrib.) - lato DX (distrib.)	2017	2022	CP071	78,00
Street Triple 765 S/R/RS	right side (clutch) - lato DX (frizione)	2017	2022	CP072	144,00
Street Triple 765 S/R/RS	left side - lato SX	2017	2022	CP073	156,00
Street Triple 765 S/R/RS	full kit - kit completo	2017	2022	CP074	377,00
Street Triple 765 R/RS/Moto 2	right side (distrib.) - lato DX (distrib.)	2023	2025	CP071	78,00
Street Triple 765 R/RS/Moto 2	right side (clutch) - lato DX (frizione)	2023	2025	CP072	144,00
Street Triple 765 R/RS/Moto 2	left side - lato SX	2023	2025	CP073	156,00
Street Triple 765 R/RS/Moto 2	full kit - kit completo	2023	2025	CP074	377,00
Speed Triple1200 RR-(RS M.Y. 2021-2024)	right side - lato DX	2021	2025	CP117	131,00
Speed Triple1200 RR-(RS M.Y. 2021-2024)	left side - lato SX	2021	2025	CP118	173,00
Speed Triple1200 RR-(RS M.Y. 2021-2024)	full kit - kit completo	2021	2025	CP119	305,00
NEW Speed Triple1200 RS/RX	right side - lato DX	2025	2025	CP130	131,00
Speed Triple1200 RS/RX	left side - lato SX	2025	2025	CP118	173,00
NEW Speed Triple1200 RS/RX	full kit - kit completo	2025	2025	CP131	305,00



TRIUMPH STREET TRIPLE 765 RS Moto2 - left side cod. CP073

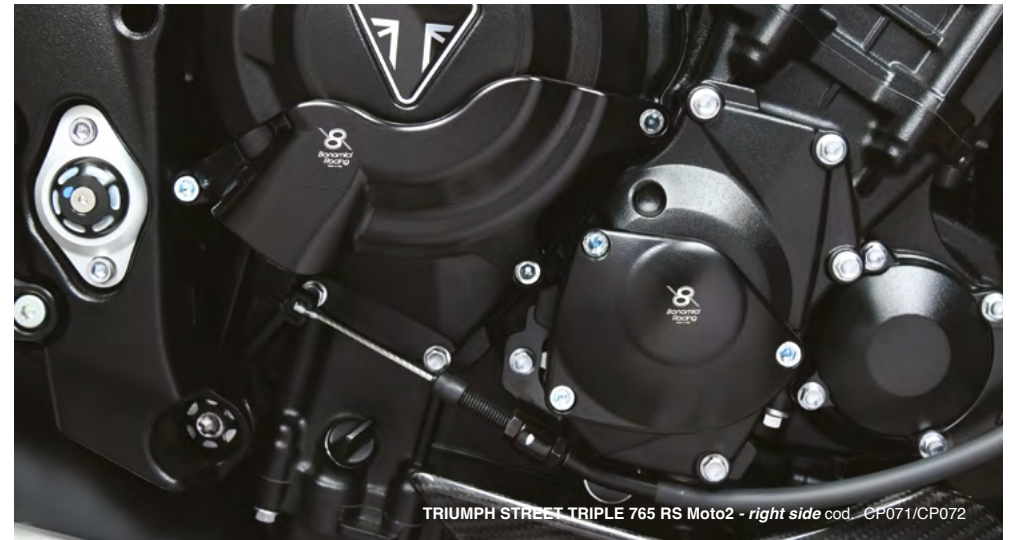

TRIUMPH STREET TRIPLE 765 RS Moto2 - right side cod. CP071/CP072

MODEL - MODELLO	DESCRIPTION - DESCRIZIONE	FROM - DAL	TO - AL	CODE - CODICE	€
YZF R6	right side (distribution) - lato DX (distribuzione)	2006	2025	CP022	59,00
YZF R6	right side (clutch) - lato DX (frizione)	2006	2025	CP023	189,00
YZF R6	left side - lato SX	2006	2025	CP024	176,00
YZF R6	full kit - kit completo	2006	2025	CP025	422,00
YZF R1/R1M	right side (distribution) - lato DX (distribuzione)	2015	2025	CP044	118,00
YZF R1/R1M	right side (clutch) - lato DX (frizione)	2015	2025	CP045	183,00
YZF R1/R1M	left side - lato SX	2015	2025	CP046	169,00
YZF R1/R1M	full kit - kit completo	2015	2025	CP047	467,00



YAMAHA YZF R6 - full kit - kit completo - cod. CP025

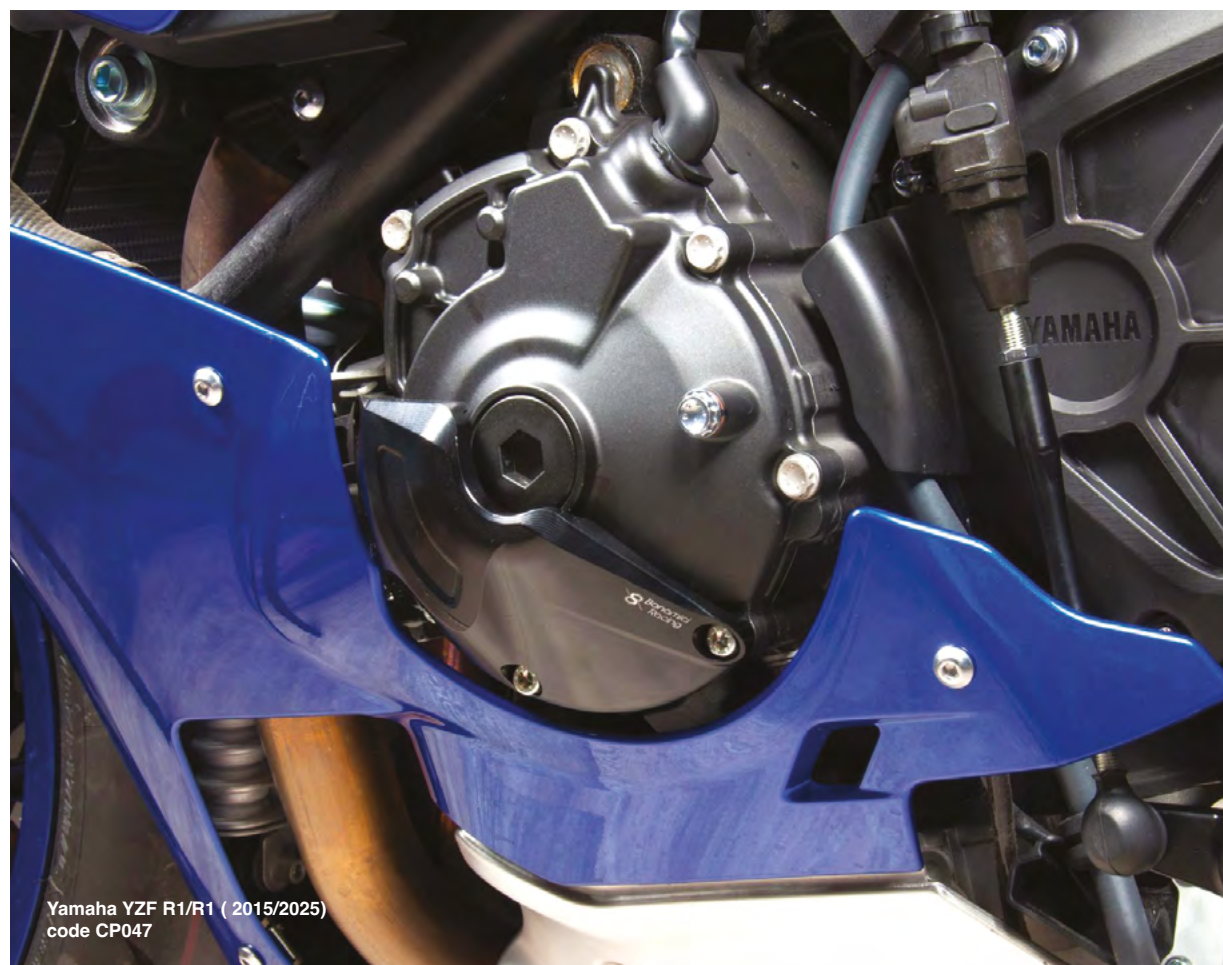

Yamaha YZF R1/R1 (2015/2025)
code CP047



YAMAHA YZF R1/R1M - full kit - kit completo - cod. CP047



CUSTOMIZATION - PERSONALIZZAZIONE

- By purchasing a new kit it is possible to request the following customization services
- Acquistando un nuovo kit è possibile richiedere i seguenti accessori

DESCRIPTION - DESCRIZIONE	CODE - CODICE	€
Laser engravings (kit - 2 engravings) - Incisioni laser (kit - 2 incisioni)	KLS2	30,00





Our dash protection, news of 2019, born from the strong demand on racing protect the latest generation displays, sophisticated and precious devices. Made from special aluminum who can absorb shocks, with cnc machining, are resistant and safe, in addition, are equipped with an interchangeable Plexiglas protective panel with anti-fog system. Standard color black or silver, other colors on request.

Le protezioni strumentazione, prodotto novità 2019, nascono direttamente dall'uso agonistico per proteggere i display di ultima generazione, veri computer sofisticati e preziosi. Realizzate in alluminio con lavorazione cnc, sono resistentissime e dotate di un pannello protettivo in plexiglas intercambiabile con sistema antiappannamento. Colore standard nero, su richiesta è possibile averle in altri colori.



Ducati Streetfighter V2 (2022/ 2024)
code DCP11

Ducati Panigale V4/V4S (2025)
code DCP25



DUCATI PANIGALE V4/V4S 2025
DUCATI STREETFIGHTER V4/V4S 2025 - cod. DCP25



BMW S 1000 RR / M1000RR / S 1000 R / S 1000 XR - cod. DCP08



HONDA CBR1000RR-R FIREBLADE - cod. DCP09

DASHBOARD PROTECTIONS - PROTEZIONI STRUMENTAZIONE

BRAND	MODEL - MODELLO	FROM - DAL	TO - AL	CODE - CODICE	€
Aprilia	RS 660 - Tuono 660	2020	2025	DCP12	201,00
Aprilia	RSV4 Factory / Tuono V4/ Tuareg 660	2021	2024	DCP13	201,00
Aprilia	RSV4 / Tuono V4	2017	2020	DCP06	201,00
BMW	S 1000 RR	2019	2025	DCP08	201,00
BMW	M 1000 RR	2021	2022	DCP08	201,00
BMW	S 1000 R - M 1000 R	2021	2025	DCP08	201,00
BMW	S 1000 XR	2020	2025	DCP08	201,00
Ducati	Panigale V2	2020	2024	DCP11	188,00
Ducati	Streetfighter V2	2022	2024	DCP11	188,00
Ducati	Panigale V4 / V4S / V4R	2018	2024	DCP03	188,00
Ducati	Panigale V4/V4S - Streetfighter V4/V4S	2025	2025	DCP25	209,00
Ducati	Streetfighter V4 / V4S	2020	2024	DCP10	188,00
Honda	CBR 600 RR	2024	2025	DCP23	193,00
Honda	CBR 1000 RR-R Fireblade	2020	2025	DCP09	191,00
Kawasaki	ZX-10R	2021	2025	DCP20	216,00
Kawasaki	ZX-4R/RR	2023	2025	DCP20	216,00
Kawasaki	ZX-6R	2024	2025	DCP20	216,00
Kawasaki	Z 900	2020	2025	DCP24	237,00
Suzuki	GSX-R 1000	2017	2025	DCP05	201,00
Suzuki	GSX-S 1000	2021	2025	DCP05	201,00
Yamaha	YZF R1 / R1M	2015	2025	DCP04	188,00
Yamaha	YZF R7	2021	2025	DCP16	193,00
Yamaha	YZF R9	2025	2025	DCP26	201,00
I2M	Chrome lite - Chrome plus	-	-	DCP02	193,00
I2M	Chrome PRO 2	-	-	DCP19	193,00
ECUMASTER	ADU5 - REV1 ***	2018	2020	DCP14	242,00
ECUMASTER	ADU5 - REV2	2021	2024	DCP15	242,00
Aim	MXm ***	-	-	DCP17	188,00
Aim	Solo 2 - Solo 2 DL**	-	-	DCP18	147,00

NEW

SCREEN SPARE PART - VETRINO DI RICAMBIO

BRAND	MODEL - MODELLO	FROM - DAL	TO - AL	CODE - CODICE	€
Aprilia	RS 660 - Tuono 660	2020	2025	SP_DCP12	20,00
Aprilia	RSV4 Factory / Tuono V4/ Tuareg 660	2021	2024	SP_DCP13	20,00
Aprilia	RSV4 / Tuono V4	2017	2020	SP_DCP06	20,00
BMW	S 1000 RR	2019	2025	SP_DCP08	34,00
BMW	M 1000 RR	2021	2022	SP_DCP08	34,00
BMW	S 1000 R - M 1000 R	2021	2025	SP_DCP08	34,00
BMW	S 1000 XR	2020	2025	SP_DCP08	34,00
Ducati	Panigale V2	2020	2024	SP_DCP11	20,00
Ducati	Streetfighter V2	2022	2024	SP_DCP11	20,00
Ducati	Panigale V4 / V4S / V4R	2018	2024	SP_DCP03	20,00
Ducati	Panigale V4/V4S - Streetfighter V4/V4S	2025	2025	SP_DCP25	20,00
Ducati	Streetfighter V4 / V4S	2020	2024	SP_DCP10	20,00
Honda	CBR 600 RR	2024	2025	SP_DCP23	20,00
Honda	CBR 1000 RR-R Fireblade	2020	2025	SP_DCP09	20,00
Kawasaki	ZX-10R	2021	2025	SP_DCP20	20,00
Kawasaki	ZX-4R/RR	2023	2025	SP_DCP20	20,00
Kawasaki	ZX-6R	2024	2025	SP_DCP20	20,00
Kawasaki	Z 900	2020	2025	SP_DCP24	20,00
Suzuki	GSX-R 1000	2017	2025	SP_DCP05	20,00
Suzuki	GSX-S 1000	2021	2025	SP_DCP05	20,00
Yamaha	YZF R1 / R1M	2015	2025	SP_DCP04	20,00
Yamaha	YZF R7	2021	2025	SP_DCP16	20,00
Yamaha	YZF R9	2025	2025	SP_DCP26	20,00
I2M	Chrome lite - Chrome plus	-	-	SP_DCP02	20,00
I2M	Chrome PRO 2	-	-	SP_DCP19	20,00
ECUMASTER	ADU5 - REV1	2018	2020	SP_DCP14	20,00
ECUMASTER	ADU5 - REV2	2021	2024	SP_DCP15	20,00
Aim	MXm	-	-	SP_DCP17	20,00
Aim	Solo 2 - Solo 2 DL	-	-	SP_DCP18	20,00

NEW

Colors available - Colori disponibili

Black 

WARNING ATTENZIONE

(*) It's possible to mount only with racing fairing - (*) Si può montare solo con le carene racing

(**) Fitting the dashboard protection may not make the GPS signal work - (**) Montando la cover potrebbe non funzionare il segnale GPS

(***) Availability is limited; this product will be supplied while stocks last - (***) Disponibilità limitata: il prodotto sarà fornito fino ad esaurimento scorte.

All Bonamici Racing dashboard protectors are not waterproof.

Tutte le protezioni strumentazione Bonamici Racing non sono a tenuta stagna.



● APRILIA RSV4 FACTORY / TUONO V4 - cod. DCP06



● YAMAHA YZF R9 - cod. DCP26



● Aim Solo2 - cod. DCP18

TOP TRIPLE CLAMP - PIASTRE DI STERZO SUPERIORI

TOP TRIPLE CLAMP STANDARD VERSION
PIASTRE DI STERZO SUPERIORI VERSIONE STANDARD



TOP TRIPLE CLAMP RACE VERSION
PIASTRE DI STERZO SUPERIORI VERSIONE RACE

The range of top triple clamps is part of Bonamici Racing innovations for 2019 and stems from the experience gained in international competitions with high-level teams.

Made from solid billet aluminum with numerical control machines, with a modern and appealing design, they are the ideal product to improve performance and driving pleasure without increasing weight.

Two types: "Race" for use on the racetrack "Standard" for the assembly of the original ignition block (where provided), no modification or adaptation is required on the stock-bike for assembly.

La gamma di piastre di sterzo superiori fa parte delle novità Bonamici Racing per il 2019 e nascono dall'esperienza maturata nelle competizioni mondiali in team di alto livello.

Realizzate in alluminio con lavorazione cnc, con un disegno moderno ed accattivante, sono il prodotto ideale per migliorare le performance ed il piacere di guida senza incrementare il peso. Due le tipologie: "Race" per l'impiego in pista e "Standard" per il montaggio del blocchetto accensione originale (dove previsto), per il montaggio non è richiesta alcuna modifica o adattamento sulla moto di serie.



Ducati Panigale V4/V4S 2025
code PSD1

TOP TRIPLE CLAMP - PIASTRE DI STERZO SUPERIORI

• Colors available • Colori disponibili



Note on Colored Anodized Components - Nota sui componenti anodizzati colorati p.148

BRAND	MODEL - MODELLO	FROM - DAL	TO - AL	COLOUR- COLORE	CODE - CODICE	€
Aprilia	RS 660	2020	2025	black - nero	PSA2	502,00
Aprilia	RS 660	2020	2025	silver - argento	PSA2_SI	502,00
Aprilia	RSV4 - RSV4 Factory "Standard"	2009	2014	black - nero	PSA1	426,00
		2019	2024			
Aprilia	RSV4 - RSV4 Factory "Race" *	2009	2014	black - nero	PSA1R	349,00
		2019	2024			
Aprilia	RSV4 - RSV4 Factory "Standard"	2009	2014	silver - argento	PSA1_SI	426,00
		2019	2024			
Aprilia	RSV4 - RSV4 Factory "Race" *	2009	2014	silver - argento	PSA1R_SI	349,00
		2019	2024			
BMW	S 1000 RR "Standard"	2015	2018	black - nero	PSB1	421,00
BMW	S 1000 RR "Race" *	2015	2018	black - nero	PSB1R	349,00
BMW	S 1000 RR "Standard"	2015	2018	silver - argento	PSB1_SI	421,00
BMW	S 1000 RR "Race" *	2015	2018	silver - argento	PSB1R_SI	349,00
BMW	S 1000 RR "Standard"	2019	2022	black - nero	PSB2	421,00
BMW	S 1000 RR "Race" *	2019	2022	black - nero	PSB2R	349,00
BMW	S 1000 RR "Standard"	2019	2022	silver - argento	PSB2_SI	421,00
BMW	S 1000 RR "Race" *	2019	2022	silver - argento	PSB2R_SI	349,00
BMW	S 1000 RR "Standard"	2023	2025	black - nero	PSB3	421,00
BMW	S 1000 RR "Race" *	2023	2025	black - nero	PSB3R	349,00
BMW	S 1000 RR "Standard"	2023	2025	silver - argento	PSB3_SI	421,00
BMW	S 1000 RR "Race" *	2023	2025	silver - argento	PSB3R_SI	349,00
BMW	M 1000 RR "Standard"	2021	2025	black - nero	PSB3	421,00
BMW	M 1000 RR "Race" *	2021	2025	black - nero	PSB3R	349,00
BMW	M 1000 RR "Standard"	2021	2025	silver - argento	PSB3_SI	421,00
BMW	M 1000 RR "Race" *	2021	2025	silver - argento	PSB3R_SI	349,00
Ducati	Panigale V2	2020	2024	black - nero	PSV2	526,00
Ducati	Panigale V2	2020	2024	silver - argento	PSV2_SI	526,00
Ducati	Panigale V4/V4S	2018	2024	black - nero	PSV4	526,00
Ducati	Panigale V4/V4S	2018	2024	silver - argento	PSV4_SI	526,00
Ducati	Panigale V4/V4S	2025	2025	black - nero	PSD1	430,00
Ducati	Panigale V4/V4S	2025	2025	silver - argento	PSD1_SI	430,00
Ducati	Panigale V4R	2019	2022	black - nero	PSV4	526,00
Ducati	Panigale V4R	2019	2022	silver - argento	PSV4_SI	526,00
Honda	CBR 1000 RR "Standard"	2017	2019	black - nero	PSH1	480,00
Honda	CBR 1000 RR "Race" *	2017	2019	black - nero	PSH1R	349,00
Honda	CBR 1000 RR "Standard"	2017	2019	silver - argento	PSH1_SI	480,00
Honda	CBR 1000 RR "Race" *	2017	2019	silver - argento	PSH1R_SI	349,00
Honda	CBR 1000RR-R Fireblade	2020	2025	black - nero	PSH2	502,00
Honda	CBR 1000RR-R Fireblade	2020	2025	silver - argento	PSH2_SI	502,00
Kawasaki	ZX-10R "Standard"	2016	2020	black - nero	PSK1	398,00
Kawasaki	ZX-10R "Race" *	2016	2020	black - nero	PSK1R	374,00
Kawasaki	ZX-10R "Standard"	2016	2020	silver - argento	PSK1_SI	398,00
Kawasaki	ZX-10R "Race" *	2016	2020	silver - argento	PSK1R_SI	374,00

BRAND	MODEL - MODELLO	FROM - DAL	TO - AL	COLOUR- COLORE	CODE - CODICE	€
Kawasaki	ZX-10R "Standard"	2021	2025	black - nero	PSK3	398,00
Kawasaki	ZX-10R "Race" *	2021	2025	black - nero	PSK3R	374,00
Kawasaki	ZX-10R "Standard"	2021	2025	silver - argento	PSK3_SI	398,00
Kawasaki	ZX-10R "Race" *	2021	2025	silver - argento	PSK3R_SI	374,00
Kawasaki	ZX-4R/RR ***	2023	2025	black - nero	PSK2	398,00
Kawasaki	ZX-4R/RR ***	2023	2025	silver - argento	PSK2_SI	398,00
Kawasaki	ZX-6R "Standard"	2020	2025	black - nero	PSK4	421,00
Kawasaki	ZX-6R "Race" *	2020	2025	black - nero	PSK4R	349,00
Kawasaki	ZX-6R "Standard"	2020	2025	silver - argento	PSK4_SI	421,00
Kawasaki	ZX-6R "Race" *	2020	2025	silver - argento	PSK4R_SI	349,00
Suzuki	GSX-R 1000 "Street"	2017	2025	black - nero	PSS1	398,00
Suzuki	GSX-R 1000 "Race" *	2017	2025	black - nero	PSS1R	349,00
Suzuki	GSX-R 1000 "Street"	2017	2025	silver - argento	PSS1_SI	398,00
Suzuki	GSX-R 1000 "Race" *	2017	2025	silver - argento	PSS1R_SI	349,00
Triumph	Speed Triple 1200 RR **	2022	2025	black - nero	PST1	502,00
Triumph	Speed Triple 1200 RR **	2022	2025	silver - argento	PST1_SI	502,00
Yamaha	YZF R6 "Standard"	2017	2025	black - nero	PSY2	398,00
Yamaha	YZF R6 "Race" *	2017	2025	black - nero	PSY2R	349,00
Yamaha	YZF R6 "Standard"	2017	2025	silver - argento	PSY2_SI	398,00
Yamaha	YZF R6 "Race" *	2017	2025	silver - argento	PSY2R_SI	349,00
Yamaha	YZF R1/R1M "Standard"	2015	2025	black - nero	PSY1	398,00
Yamaha	YZF R1/R1M "Race" *	2015	2025	black - nero	PSY1R	349,00
Yamaha	YZF R1/R1M "Standard"	2015	2025	silver - argento	PSY1_SI	398,00
Yamaha	YZF R1/R1M "Race" *	2015	2025	silver - argento	PSY1R_SI	349,00
Yamaha	YZF R7 "Standard"	2021	2025	black - nero	PSY3	398,00
Yamaha	YZF R7 "Race" *	2021	2025	black - nero	PSY3R	363,00
Yamaha	YZF R7 "Standard"	2021	2025	silver - argento	PSY3_SI	398,00
Yamaha	YZF R7 "Race" *	2021	2025	silver - argento	PSY3R_SI	363,00
Yamaha	YZF R9 "Standard"	2025	2025	black - nero	PSY4	398,00
Yamaha	YZF R9 "Race" *	2025	2025	black - nero	PSY4R	349,00
Yamaha	YZF R9 "Standard"	2025	2025	silver - argento	PSY4_SI	398,00
Yamaha	YZF R9 "Race" *	2025	2025	silver - argento	PSY4R_SI	349,00

NEW

NEW

TOP TRIPLE CLAMP NUT - DADO PIASTRA DI STERZO SUPERIORE

MODEL - MODELLO	COLOUR - COLORE	CODE - CODICE	€
Yamaha YZF R7 (2021-2025)	black - nero	DD3_BK	47,00
Triumph Speed Triple 1200 RR (2022-2025)	black - nero	DD4_BK	47,00

WARNING ATTENZIONE

(*) is not possible to mount the OEM ignition switch key
 (*) non è possibile rimontare il bloccetto accensione originale
 (**) Equipped with the top tripleclamp plate nut, it is recommended to apply a light layer of grease when fitting the nut
 (***) Dotata del dado della piastra di sterzo, si consiglia al momento del montaggio del dado di applicare un leggero strato di grasso

(***) It is possible to use the top triple clamp in both Racing and Standard mode as it is equipped with a removable support for the ignition lock
 (***) È possibile utilizzare la piastra sia in modalità Racing che Standard perché dotata di supporto amovibile per il bloccetto di accensione.



• APRILIA RSV4 "Standard" - code PSA1



• BMW S 1000 RR "Standard" - code PSB3



• YAMAHA YZF R9 "Standard" - code PSY4



YAMAHA YZF R9 (2025)
"Race Version" code PSY1R_SI



• DUCATI PANIGALE V4 -V4S (2025) - code PSD1



- Titanium tightening screws on the forks
- Viti di serraggio sulle forcelle in titanio



The new range of brake and clutch lever controls has been redesigned to offer a better feeling of riding with your bike. Made of aluminum machined from solid with foldable lever, are equipped with a hole for air outflow who prevents the actuation if subject to the aerodynamic force. The new levers are more resistant and offer even more precise adjustment, moreover they have more excursion in order to adapt to any type of use. The final tilting part have a shape designed to offer the best grip and ergonomics. More shapes are available on request to satisfy every driving style.

La nuova gamma di comandi leva per freno e frizione è stata riprogettata per offrire un maggior feeling di guida con la propria moto. Realizzate in alluminio ricavate dal pieno con leva ribaltabile, sono dotate di foro per il deflusso aerodinamico che impedisce l'azionamento se soggette alla forza dell'aria. Le nuove leve sono più resistenti ed offrono una regolazione ancora più precisa e con più escursione in modo da adattarsi ad ogni tipo di utilizzo. Hanno inoltre la parte ribaltabile con una forma studiata per offrire la migliore presa ed ergonomia e sono disponibili su richiesta altre forme in modo da soddisfare ogni stile di guida.



APRILIA

MODEL - MODELLO	DESCRIPTION - DESCRIZIONE	FROM - DAL	TO - AL	CODE - CODICE	€
RSV4 - Factory - APRC	Levers kit - Kit leve	2009	2024	KL010	272,00
RSV4 - Factory - APRC	Brake lever - Leva freno	2009	2024	LB110	161,00
RSV4 - Factory - APRC	Clutch lever - Leva frizione	2009	2024	LC010	128,00
Tuono 1100	Levers kit - Kit leve	2017	2024	KL010	272,00
Tuono 1100	Brake lever - Leva freno	2017	2024	LB110	161,00
Tuono 1100	Clutch lever - Leva frizione	2017	2024	LC010	128,00
RS 660 - Tuono 660	Levers kit - Kit leve	2020	2025	KL010	272,00
RS 660 - Tuono 660	Brake lever - Leva freno	2020	2025	LB110	161,00
RS 660 - Tuono 660	Clutch lever - Leva frizione	2020	2025	LC010	128,00
Tuareg 660	Levers kit - Kit leve	2021	2025	KL370	294,00
Tuareg 660	Brake lever - Leva freno	2021	2025	LB230	183,00
Tuareg 660	Clutch lever - Leva frizione	2021	2025	LC010	128,00



APRILIA RSV4 - FACTORY - APRC - Levers kit - Kit leve - cod. KL010

BMW

MODEL - MODELLO	DESCRIPTION - DESCRIZIONE	FROM - DAL	TO - AL	CODE - CODICE	€
S 1000 RR - HP4	Levers kit - Kit leve	2008	2014	KL020	272,00
S 1000 RR - HP4	Brake lever - Leva freno	2008	2014	LB090	161,00
S 1000 RR - HP4	Clutch lever - Leva frizione	2008	2014	LC070	128,00
S 1000 RR	Levers kit - Kit leve	2015	2018	KL220	286,00
S 1000 RR	Brake lever - Leva freno	2015	2018	LB090	161,00
S 1000 RR	Clutch lever - Leva frizione	2015	2018	LC140	143,00
S 1000 RR * **	Levers kit - Kit leve	2019	2025	KL290	286,00
S 1000 RR *	Brake lever - Leva freno	2019	2025	LB090	161,00
S 1000 RR **	Clutch lever - Leva frizione	2019	2025	LC170	143,00
M 1000 RR * **	Levers kit - Kit leve	2021	2025	KL290	286,00
M 1000 RR *	Brake lever - Leva freno	2021	2025	LB090	161,00
M 1000 RR **	Clutch lever - Leva frizione	2021	2025	LC170	143,00
S 1000 R	Levers kit - Kit leve	2012	2020	KL220	286,00
S 1000 R	Brake lever - Leva freno	2012	2020	LB090	161,00
S 1000 R	Clutch lever - Leva frizione	2012	2020	LC140	143,00
S 1000 R - M 1000 R **	Levers kit - Kit leve	2021	2025	KL270	286,00
S 1000 R - M 1000 R	Brake lever - Leva freno	2021	2025	LB200	161,00
S 1000 R - M 1000 R **	Clutch lever - Leva frizione	2021	2025	LC170	143,00
S 1000 XR **	Levers kit - Kit leve	2020	2025	KL270	286,00
S 1000 XR	Brake lever - Leva freno	2020	2025	LB200	161,00
S 1000 XR **	Clutch lever - Leva frizione	2020	2025	LC170	143,00



BMW S 1000 RR - Levers kit - Kit leve - cod. KL290



BMW S 1000 R - Levers kit - Kit leve - cod. KL270

(*) The brake lever may touch with the knob on the instrument frame, when the motorcycle is understeer.

(**) The plastic protection cannot be remounted on the clutch lever.

(*) La leva freno quando la moto è sottosterzo, potrebbe toccare con il pomello sul telaio porta strumentazione.

(**) Non è possibile rimontare la protezione in plastica sulla leva frizione.



BMW S 1000 RR (2023/2025)
Brake lever - code LB090

Ducati Panigale V4 (2025)
Clutch lever - code LC260



DUCATI



● **DUCATI Panigale V4/V4S 2025 Levers kit - Kit leve - cod. KL450**



NEW
NEW
NEW

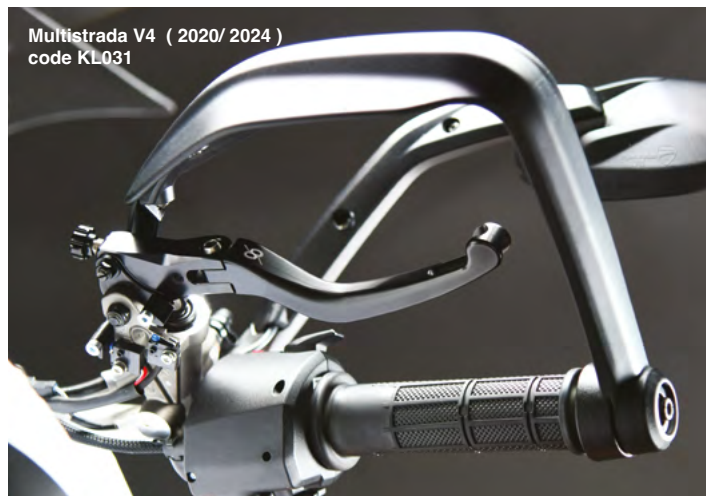

MODEL - MODELLO	DESCRIPTION - DESCRIZIONE	FROM - DAL	TO - AL	CODE - CODICE	€
Monster 1100	Levers kit - Kit leve	2010	2016	KL031	300,00
Monster 1100	Brake lever - Leva freno	2010	2016	LB140	161,00
Monster 1100	Clutch lever - Leva frizione	2010	2016	LC061	157,00
Monster 1200	Levers kit - Kit leve	2014	2018	KL031	300,00
Monster 1200	Brake lever - Leva freno	2014	2018	LB140	161,00
Monster 1200	Clutch lever - Leva frizione	2014	2018	LC061	157,00
749/999	Levers kit - Kit leve	2002	2006	KL031	300,00
749/999	Brake lever - Leva freno	2002	2006	LB140	161,00
749/999	Clutch lever - Leva frizione	2002	2006	LC061	157,00
848/1098/1198	Levers kit - Kit leve	2007	2012	KL031	300,00
848/1098/1198	Brake lever - Leva freno	2007	2012	LB140	161,00
848/1098/1198	Clutch lever - Leva frizione	2007	2012	LC061	157,00
Panigale V2 899 - 959 - 1199 - 1299 Panigale	Levers kit - Kit leve	2012	2022	KL031	300,00
Panigale V2 899 - 959 - 1199 - 1299 Panigale	Brake lever - Leva freno	2012	2022	LB140	161,00
Panigale V2 899 - 959 - 1199 - 1299 Panigale	Clutch lever - Leva frizione	2012	2022	LC061	157,00
Panigale V2	Levers kit - Kit leve	2023	2024	KL380	300,00
Panigale V2	Brake lever - Leva freno	2023	2024	LB240	161,00
Panigale V2	Clutch lever - Leva frizione	2023	2024	LC061	157,00
Panigale V4 / V4S / V4R	Levers kit - Kit leve	2018	2022	KL031	300,00
Panigale V4 / V4S / V4R	Brake lever - Leva freno	2018	2022	LB140	161,00
Panigale V4 / V4S / V4R	Clutch lever - Leva frizione	2018	2022	LC061	157,00
Panigale V4 / V4S / V4R	Levers kit - Kit leve	2023	2024	KL380	300,00
Panigale V4 / V4S / V4R	Brake lever - Leva freno	2023	2024	LB240	161,00
Panigale V4 / V4S / V4R	Clutch lever - Leva frizione	2023	2024	LC061	157,00
Panigale V4 / V4S *	Levers kit - Kit leve	2025	2025	KL450	300,00
Panigale V4 / V4S *	Brake lever - Leva freno	2025	2025	LB270	161,00
Panigale V4 / V4S	Clutch lever - Leva frizione	2025	2025	LC260	157,00
Streetfighter 848 / 1100	Levers kit - Kit leve	2009	2016	KL031	300,00
Streetfighter 848 / 1100	Brake lever - Leva freno	2009	2016	LB140	161,00
Streetfighter 848 / 1100	Clutch lever - Leva frizione	2009	2016	LC061	157,00
Streetfighter V2	Levers kit - Kit leve	2022	2024	KL380	300,00
Streetfighter V2	Brake lever - Leva freno	2022	2024	LB240	161,00
Streetfighter V2	Clutch lever - Leva frizione	2022	2024	LC061	157,00
Streetfighter V4 / V4S	Levers kit - Kit leve	2020	2022	KL031	300,00
Streetfighter V4 / V4S	Brake lever - Leva freno	2020	2022	LB140	161,00
Streetfighter V4 / V4S	Clutch lever - Leva frizione	2020	2022	LC061	157,00
Streetfighter V4 / V4S	Levers kit - Kit leve	2023	2025	KL380	300,00
Streetfighter V4 / V4S	Brake lever - Leva freno	2023	2025	LB240	161,00
Streetfighter V4 / V4S	Clutch lever - Leva frizione	2023	2025	LC061	157,00
Multistrada V2 / V2S	Levers kit - Kit leve	2021	2024	KL032	300,00
Multistrada V2 / V2S	Brake lever - Leva freno	2021	2024	LB141	161,00
Multistrada V2 / V2S	Clutch lever - Leva frizione	2021	2024	LC062	157,00
Multistrada V4 V4S / V4S Sport / V4 Pikes Peak	Levers kit - Kit leve	2020	2024	KL380	300,00
Multistrada V4 V4S / V4S Sport / V4 Pikes Peak	Brake lever - Leva freno	2020	2024	LB240	161,00
Multistrada V4 V4S / V4S Sport / V4 Pikes Peak	Clutch lever - Leva frizione	2020	2024	LC061	157,00

(*) The brake lever may touch with the knob on the instrument frame, when the motorcycle is understeer.
(*) La leva freno quando la moto è sottosterzo, potrebbe toccare con il pomello sul telaio porta strumentazione.

HONDA

MODEL - MODELLO	DESCRIPTION - DESCRIZIONE	FROM - DAL	TO - AL	CODE - CODICE	€
CBR 600 RR	Levers kit - Kit leve	2007	2025	KL040	272,00
CBR 600 RR	Brake lever - Leva freno	2007	2025	LB150	161,00
CBR 600 RR	Clutch lever - Leva frizione	2007	2025	LC020	128,00
CBR 1000 RR	Levers kit - Kit leve	2008	2019	KL040	272,00
CBR 1000 RR	Brake lever - Leva freno	2008	2019	LB150	161,00
CBR 1000 RR	Clutch lever - Leva frizione	2008	2019	LC020	128,00
CBR 1000 RR-R Fireblade	Levers kit - Kit leve	2020	2025	KL040	272,00
CBR 1000 RR-R Fireblade	Brake lever - Leva freno	2020	2025	LB150	161,00
CBR 1000 RR-R Fireblade	Clutch lever - Leva frizione	2020	2025	LC020	128,00
CBR 1000 RR-R Fireblade SP	Levers kit - Kit leve	2020	2025	KL310	272,00
CBR 1000 RR-R Fireblade SP	Brake lever - Leva freno	2020	2025	LB110	161,00
CBR 1000 RR-R Fireblade SP	Clutch lever - Leva frizione	2020	2025	LC020	128,00



HONDA CBR1000RR-R FIREBLADE SP
Levers kit - Kit leve - cod. KL310



KAWASAKI



KAWASAKI ZX-4R/RR - Z 900
Levers kit - Kit leve - cod. KL410



KAWASAKI ZX-10R (2016 - 2024)
Levers kit - Kit leve - cod. KL210



KTM 790 DUKE - Levers kit - Kit leve - cod. KL300

MODEL - MODELLO	DESCRIPTION - DESCRIZIONE	FROM - DAL	TO - AL	CODE - CODICE	€
Ninja 300 (ZX-3R)	Levers kit - Kit leve	2014	2017	KL260	272,00
Ninja 300 (ZX-3R)	Brake lever - Leva freno	2014	2017	LB180	161,00
Ninja 300 (ZX-3R)	Clutch lever - Leva frizione	2014	2017	LC160	128,00
Ninja 250/400	Levers kit - Kit leve	2018	2023	KL260	272,00
Ninja 250/400	Brake lever - Leva freno	2018	2023	LB180	161,00
Ninja 250/400	Clutch lever - Leva frizione	2018	2023	LC160	128,00
ZX-4R/RR	Levers kit - Kit leve	2023	2025	KL410	300,00
ZX-4R/RR	Brake lever - Leva freno	2023	2025	LB260	161,00
ZX-4R/RR	Clutch lever - Leva frizione	2023	2025	LC240	157,00
ZX-6R - ZX-6R 636	Levers kit - Kit leve	2005	2017	KL110	272,00
ZX-6R - ZX-6R 636	Brake lever - Leva freno	2005	2017	LB160	161,00
ZX-6R - ZX-6R 636	Clutch lever - Leva frizione	2005	2017	LC040	128,00
ZX-6R	Levers kit - Kit leve	2020	2025	KL440	300,00
ZX-6R	Brake lever - Leva freno	2020	2025	LB160	161,00
ZX-6R	Clutch lever - Leva frizione	2020	2025	LC240	157,00
ZX-10R	Levers kit - Kit leve	2006	2015	KL110	272,00
ZX-10R	Brake lever - Leva freno	2006	2015	LB160	161,00
ZX-10R	Clutch lever - Leva frizione	2006	2015	LC040	128,00
ZX-10R	Levers kit - Kit leve	2016	2025	KL210	272,00
ZX-10R	Brake lever - Leva freno	2016	2025	LB110	161,00
ZX-10R	Clutch lever - Leva frizione	2016	2025	LC040	128,00
Z 900	Levers kit - Kit leve	2017	2025	KL410	300,00
Z 900	Brake lever - Leva freno	2017	2025	LB260	161,00
Z 900	Clutch lever - Leva frizione	2017	2025	LC240	157,00

KTM

MODEL - MODELLO	DESCRIPTION - DESCRIZIONE	FROM - DAL	TO - AL	CODE - CODICE	€
790/890 Duke	Levers kit - Kit leve	2018	2023	KL300	286,00
790/890 Duke	Brake lever - Leva freno	2018	2023	LB190	161,00
790/890 Duke	Clutch lever - Leva frizione	2018	2023	LC180	143,00
890 Duke R	Levers kit - Kit leve	2021	2023	KL320	286,00
890 Duke R	Brake lever - Leva freno	2021	2023	LB210	161,00
890 Duke R	Clutch lever - Leva frizione	2021	2023	LC180	143,00
1290 Super Duke R	Levers kit - Kit leve	2020	2023	KL280	286,00
1290 Super Duke R	Brake lever - Leva freno	2020	2023	LB110	161,00
1290 Super Duke R	Clutch lever - Leva frizione	2020	2023	LC200	143,00
1390 Super Duke R	Levers kit - Kit leve	2024	2025	KL420	300,00
1390 Super Duke R	Brake lever - Leva freno	2024	2025	LB210	161,00
1390 Super Duke R	Clutch lever - Leva frizione	2024	2025	LC061	157,00

MV AGUSTA

MODEL - MODELLO	DESCRIPTION - DESCRIZIONE	FROM - DAL	TO - AL	CODE - CODICE	€
F3 675/ F3 800	Levers kit - Kit leve	2011	2024	KL200	272,00
F3 675/ F3 800	Brake lever - Leva freno	2011	2024	LB090	161,00
F3 675/ F3 800	Clutch lever - Leva frizione	2011	2024	LC110	128,00



Triumph Street Triple 765 Moto 2 Edition (2023/ 2025) clutch lever - code LC230

SUZUKI



SUZUKI GSX-R 1000 - Levers kit - Kit leve - cod. KL170



TRIUMPH STREET TRIPLE 765 R - Levers kit - Kit leve - cod. KL390



TRIUMPH SPEED TRIPLE 1200 RR/RS - Levers kit - Kit leve - cod. KL360

MODEL - MODELLO	DESCRIPTION - DESCRIZIONE	FROM - DAL	TO - AL	CODE - CODICE	€
GSX-R 600/ GSX-R 750	Levers kit - Kit leve	2006	2010	KL120	272,00
GSX-R 600/ GSX-R 750	Brake lever - Leva freno	2006	2010	LB090	161,00
GSX-R 600/ GSX-R 750	Clutch lever - Leva frizione	2006	2010	LC010	128,00
GSX-R 600/ GSX-R 750	Levers kit - Kit leve	2011	2017	KL170	272,00
GSX-R 600/ GSX-R 750	Brake lever - Leva freno	2011	2017	LB090	161,00
GSX-R 600/ GSX-R 750	Clutch lever - Leva frizione	2011	2017	LC090	128,00
GSX-R 1000	Levers kit - Kit leve	2005	2006	KL120	272,00
GSX-R 1000	Brake lever - Leva freno	2005	2006	LB090	161,00
GSX-R 1000	Clutch lever - Leva frizione	2005	2006	LC010	128,00
GSX-R 1000	Levers kit - Kit leve	2009	2010	KL120	272,00
GSX-R 1000	Brake lever - Leva freno	2009	2010	LB090	161,00
GSX-R 1000	Clutch lever - Leva frizione	2009	2010	LC010	128,00
GSX-R 1000	Levers kit - Kit leve	2011	2025	KL170	272,00
GSX-R 1000	Brake lever - Leva freno	2011	2025	LB090	161,00
GSX-R 1000	Clutch lever - Leva frizione	2011	2025	LC090	128,00
GSX-S 1000	Levers kit - Kit leve	2021	2025	KL330	272,00
GSX-S 1000	Brake lever - Leva freno	2021	2025	LB201	161,00
GSX-S 1000	Clutch lever - Leva frizione	2021	2025	LC210	128,00
GSX-8S/8R	Levers kit - Kit leve	2023	2025	KL430	272,00
GSX-8S/8R	Brake lever - Leva freno	2023	2025	LB201	161,00
GSX-8S/8R	Clutch lever - Leva frizione	2023	2025	LC250	128,00

TRIUMPH

MODEL - MODELLO	DESCRIPTION - DESCRIZIONE	FROM - DAL	TO - AL	CODE - CODICE	€
Daytona 675 R	Levers kit - Kit leve	2011	2016	KL180	272,00
Daytona 675 R	Brake lever - Leva freno	2011	2016	LB110	161,00
Daytona 675 R	Clutch lever - Leva frizione	2011	2016	LC080	128,00
Daytona 675	Clutch lever - Leva frizione	2011	2016	LC080	128,00
Speed Triple 1050/1050 R	Levers kit - Kit leve	2011	2017	KL180	272,00
Speed Triple 1050/1050 R	Brake lever - Leva freno	2011	2017	LB110	161,00
Speed Triple 1050/1050 R	Clutch lever - Leva frizione	2011	2017	LC080	128,00
Street Triple 765 R	Levers kit - Kit leve	2023	2025	KL390	272,00
Street Triple 765 R	Brake lever - Leva freno	2023	2025	LB200	161,00
Street Triple 765 R	Clutch lever - Leva frizione	2023	2025	LC080	128,00
Street Triple 765 RS/Moto 2	Levers kit - Kit leve	2023	2025	KL360	286,00
Street Triple 765 RS/Moto 2	Brake lever - Leva freno	2023	2025	LB210	161,00
Street Triple 765 RS/Moto 2	Clutch lever - Leva frizione	2023	2025	LC230	143,00
Speed Triple 1200 RR/RS/RX	Levers kit - Kit leve	2021	2025	KL360	286,00
Speed Triple 1200 RR/RS/RX	Brake lever - Leva freno	2021	2025	LB210	161,00
Speed Triple 1200 RR/RS/RX	Clutch lever - Leva frizione	2021	2025	LC230	143,00

MODEL - MODELLO	DESCRIPTION - DESCRIZIONE	FROM - DAL	TO - AL	CODE - CODICE	€
YZF R3	Levers kit - Kit leve	2015	2025	KL250	272,00
YZF R3	Brake lever - Leva freno	2015	2025	LB170	161,00
YZF R3	Clutch lever - Leva frizione	2015	2025	LC150	128,00
YZF R6	Levers kit - Kit leve	2006	2016	KL240	272,00
YZF R6	Brake lever - Leva freno	2006	2016	LB140	161,00
YZF R6	Clutch lever - Leva frizione	2006	2016	LC010	128,00
YZF R6	Levers kit - Kit leve	2017	2025	KL230	272,00
YZF R6	Brake lever - Leva freno	2017	2025	LB100	161,00
YZF R6	Clutch lever - Leva frizione	2017	2025	LC010	128,00
YZF R1	Levers kit - Kit leve	2004	2014	KL240	272,00
YZF R1	Brake lever - Leva freno	2004	2014	LB140	161,00
YZF R1	Clutch lever - Leva frizione	2004	2014	LC010	128,00
YZF R1/R1M (Nissin brake pump)	Levers kit - Kit leve	2015	2025	KL231	272,00
YZF R1/R1M (Nissin brake pump)	Brake lever - Leva freno On this lever is not possible mount the remote adjuster. The lever with remote adjuster for YZF R1 '15/2025 has code RALB100. Su questa leva non è possibile montare il registro remoto. L'unica leva con registro remoto utilizzabile sulla YZF R1 '15/2025 è quella con codice RALB100	2015	2025	LB101	161,00
YZF R1/R1M (Brembo brake pump)	Levers kit - Kit leve	2025	2025	KL340	299,00
YZF R1/R1M (Brembo brake pump)	Brake lever - Leva freno It can only be mounted on Bonamici Racing Clip-ons Code SM50B Può essere montata solo sui semimanubri Bonamici Racing Codice SM50B	2025	2025	LB220	172,00
YZF R1/R1M	Clutch lever - Leva frizione	2015	2025	LC010	128,00
YZF R7	Levers kit - Kit leve	2021	2025	KL340	299,00
YZF R7	Brake lever - Leva freno It can only be mounted on Bonamici Racing Clip-ons Code SM50B Può essere montata solo sui semimanubri Bonamici Racing Codice SM50B	2021	2025	LB220	172,00
YZF R7	Clutch lever - Leva frizione	2021	2025	LC010	128,00
MT-09	Levers kit - Kit leve	2021	2023	KL231	272,00
MT-09	Brake lever - Leva freno	2021	2023	LB101	161,00
MT-09	Clutch lever - Leva frizione	2021	2023	LC010	128,00
NEW NEW NEW YZF R9	Levers kit - Kit leve	2025	2025	KL460	331,00
YZF R9	Brake lever - Leva freno	2025	2025	LB280	174,00
YZF R9	Clutch lever - Leva frizione	2025	2025	LC270	157,00



YAMAHA YZF R6 2017 - Levers kit - Kit leve - cod. KL230



YAMAHA YZF R1/R1M - Levers kit - Kit leve - cod. KL231



YAMAHA YZF R9 - Levers kit - Kit leve - cod. KL460

BREMBO



● **BREMBO CORSA CORTA - Brake lever- Leva freno - cod. LB120CC**

MODEL - MODELLO	DESCRIPTION - DESCRIZIONE	FROM - DAL	TO - AL	CODE - CODICE	€
16 X 18 - 19 X 18	Brake lever - Leva freno	-	-	LB070	128,00
19 X 20	Brake lever - Leva freno	-	-	LB080	128,00
RCS	Brake lever - Leva freno	-	-	LB120	128,00
	Aluminium half lever Solo la parte terminale in alluminio				
Racing	Brake lever - Leva freno	-	-	LB120R	128,00
	Aluminium half lever Solo la parte terminale in alluminio				
Corsa Corta	Brake lever - Leva freno	-	-	LB120CC	128,00
	Aluminium half lever Solo la parte terminale in alluminio				
MCS	Brake lever - Leva freno	-	-	LB210	161,00



Yamaha YZF R9 (2025)
Brake lever - code LB280

COMPLETE CLUTCH LEVERS - LEVE FRIZIONE COMPLETE

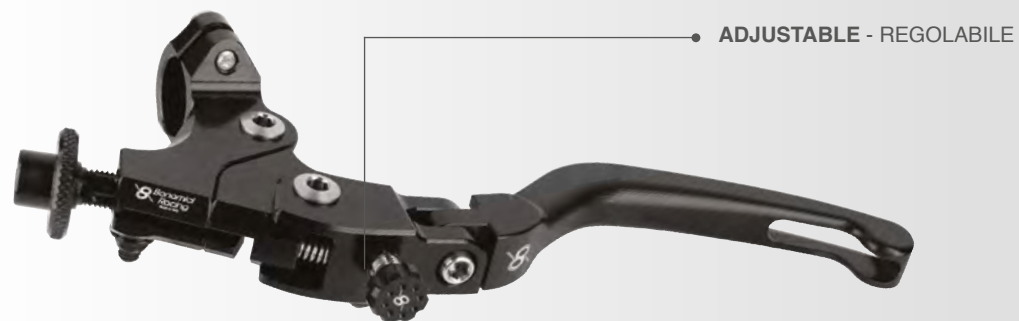

ADJUSTABLE - REGOLABILE

DESCRIPTION - DESCRIZIONE	CODE - CODICE	€
Offset 24mm	LCFR24	254,00
Offset 27mm	LCFR27	254,00
Offset 29mm	LCFR29	254,00
Offset 32mm	LCFR32	254,00
Offset 34mm	LCFR34	254,00

NON-ADJUSTABLE - NON REGOLABILE

DESCRIPTION - DESCRIZIONE	CODE - CODICE	€
Offset 24mm	LCF24	190,00
Offset 27mm	LCF27	190,00
Offset 29mm	LCF29	190,00
Offset 32mm	LCF32	190,00
Offset 34mm	LCF34	190,00

WARNING ATTENZIONE

Product for racing use only, it is not possible to install the (OEM) switch
Prodotto esclusivamente per uso racing, non è possibile installare lo switch di serie

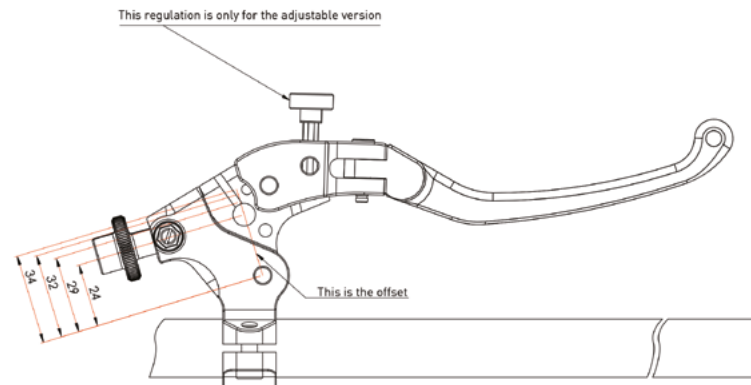

NOTES - NOTE

HOW TO CHOSE THE OFFSET

At the purchase time it is necessary to choose the ideal offset keeping in mind the following: greater is the offset, greater will be the hardness of the lever with a faster detachment. To determine the offset of the original lever, perform the measurement as in the picture.

COME SCEGLIERE L'OFFSET

Al momento dell'acquisto occorre scegliere l'offset ideale tenendo presente che maggiore è l'offset e maggiore sarà la durezza della leva con uno stacco più rapido.
Per stabilire l'offset della leva originale eseguire la misurazione come in foto

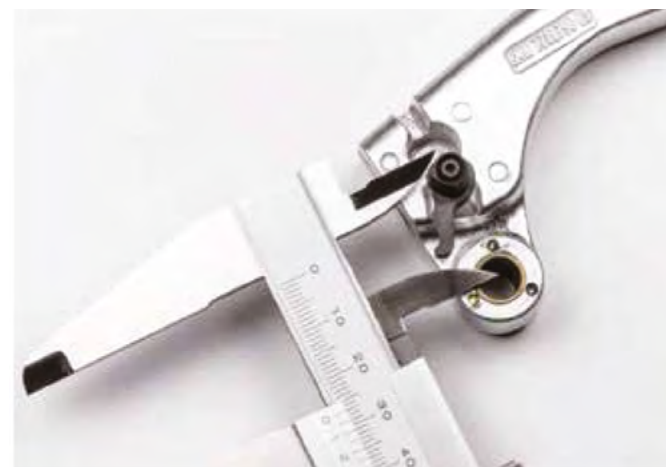



BRAKE LEVERS WITH REMOTE ADJUSTER - LEVE FRENO CON REGISTRO REMOTO



BRAKE LEVERS WITH RACING REMOTE ADJUSTER
LEVE FRENO CON REGISTRO REMOTO RACING



BRAKE LEVERS WITH REMOTE ADJUSTER
LEVE FRENO CON REGISTRO REMOTO

BRAND	MODEL - MODELLO	FROM - DAL	TO - AL	CODE - CODICE	€	CODE - CODICE	€
				Standard version		Racing version	
Aprilia	RS 660 - TUONO 660	2020	2025	RALB110	279,00	RALB110R	396,00
Aprilia	RSV4 - Factory - APRC	2009	2024	RALB110	279,00	RALB110R	396,00
Aprilia	Tuono 1100	2017	2020	RALB110	279,00	RALB110R	396,00
BMW	S 1000 R	2012	2020	RALB090	279,00	RALB090R	396,00
BMW	S 1000 R - M 1000 R	2021	2025	RALB200	279,00	RALB200R	396,00
BMW	S 1000 RR - M 1000 RR - HP4	2008	2025	RALB090	279,00	RALB090R	396,00
Ducati	749/999	2002	2006	RALB140	279,00	RALB140R	396,00
Ducati	848/1098/1198	2007	2012	RALB140	279,00	RALB140R	396,00
Ducati	899/1199/1299 Panigale/V2	2012	2024	RALB140	279,00	RALB140R	396,00
Ducati	Streetfighter V2	2022	2024	RALB240	279,00	RALB240R	396,00
Ducati	Streetfighter V4	2020	2022	RALB140	279,00	RALB140R	396,00
Ducati	Streetfighter V4	2023	2025	RALB240	279,00	RALB240R	396,00
Ducati	Panigale V4/V4S/V4R	2018	2022	RALB140	279,00	RALB140R	396,00
Ducati	Panigale V2/V4/V4S/V4R	2023	2025	RALB240	279,00	RALB240R	396,00
Honda	CBR 500 R - CB 500 F	2019	2024	RALB180	279,00	RALB180R	396,00
Honda	CBR 600 RR	2007	2025	RALB150	279,00	RALB150R	396,00
Honda	CBR 1000 RR	2004	2019	RALB150	279,00	RALB150R	396,00
Honda	CBR 1000 RR-R Fireblade	2020	2025	RALB150	279,00	RALB150R	396,00
Honda	CBR 1000 RR-R Fireblade SP	2020	2025	RALB110	279,00	RALB110R	396,00
Kawasaki	Ninja 300 (ZX-3R)	2014	2017	RALB180	279,00	RALB180R	396,00
Kawasaki	Ninja 250/400	2018	2023	RALB180	279,00	RALB180R	396,00
Kawasaki	ZX-4R/RR	2023	2025	RALB260	279,00	RALB260R	396,00
Kawasaki	Z 900	2017	2025	RALB260	279,00	RALB260R	396,00
Kawasaki	ZX-6R	2005	2017	RALB160	279,00	RALB160R	396,00
Kawasaki	ZX-6R	2024	2025	RALB160	279,00	RALB160R	396,00
Kawasaki	ZX-10R	2006	2015	RALB160	279,00	RALB160R	396,00
Kawasaki	ZX-10R	2016	2025	RALB110	279,00	RALB110R	396,00
KTM	790 / 890 Duke	2018	2023	RALB190	279,00	RALB190R	396,00
KTM	890 Duke R	2021	2023	RALB210	279,00	RALB210R	396,00
KTM	1290 Super Duke R	2020	2023	RALB110	279,00	RALB110R	396,00
KTM	1390 Super Duke R	2024	2025	RALB210	279,00	RALB210R	396,00
MV Agusta	F3 675/800	2011	2024	RALB090	279,00	RALB090R	396,00
Suzuki	GSX-R 600/750/1000	2004	2024	RALB090	279,00	RALB090R	396,00
Suzuki	GSX-S 1000 / GSX 8R-8S	2021	2025	RALB201	279,00	RALB201R	396,00
Triumph	Daytona 675 R	2011	2016	RALB110	279,00	RALB110R	396,00
Triumph	Speed triple 1200 RR/RS/RX	2021	2025	RALB210	279,00	RALB210R	396,00
Triumph	Street triple 765 R	2023	2025	RALB200	279,00	RALB200R	396,00
Triumph	Street triple 765 RS/Moto 2	2023	2025	RALB210	279,00	RALB210R	396,00
Yamaha	YZF R3	2015	2025	RALB170	279,00	RALB170R	396,00
Yamaha	YZF R6	2006	2016	RALB140	279,00	RALB140R	396,00
Yamaha	YZF R6	2017	2025	RALB100	279,00	RALB100R	396,00
Yamaha	YZF R1	2004	2014	RALB140	279,00	RALB140R	396,00
Yamaha	YZF R1/R1M (Nissin Pump)	2015	2025	RALB100	279,00	RALB100R	396,00
Yamaha	YZF R1/R1M (Brembo Pump)	2025	2025	RALB220	290,00	RALB220R	422,00
Yamaha	YZF R7	2021	2025	RALB220	290,00	RALB220R	422,00
Yamaha	YZF R9	2025	2025	RALB220	290,00	RALB220R	422,00
Brembo	16x18	-	-	RALB070	237,00	RALB070R	381,00
Brembo	19x18	-	-	RALB070	237,00	RALB070R	381,00
Brembo	19x20	-	-	RALB080	237,00	RALB080R	381,00
Brembo	MCS	-	-	RALB210	279,00	RALB210R	396,00

REMOTE ADJUSTER - REGISTRO REMOTO

MODEL - MODELLO	CODE - CODICE	€
Cable length 52,5 mm - Lunghezza cavo 52,5 mm	00BRC	109,00
Cable length 75,5 mm - Lunghezza cavo 77,5 mm	00BRL	109,00
Braking	0042	109,00
Brembo original pump - Brembo pompa di serie	0037	109,00
Brembo 16x18/19x18/19x20	0037R	109,00
Brembo RCS/RCS Corsa Corta	0043	109,00
Discacciati	0038	109,00
PT	0041	109,00



RACING REMOTE ADJUSTER - REGISTRO REMOTO RACING

MODEL - MODELLO	CODE - CODICE	€
Cable length 52.5 mm - Lunghezza cavo 52,5 mm	RRP_BRC	184,00
Cable length 77.5 mm - Lunghezza cavo 77,5 mm	RRP_BRL	184,00
Brembo original pump - Brembo pompa di serie	RRP_37	184,00
Brembo 16x18/19x18/19x20	RRP_37R	184,00
Brembo RCS/RCS Corsa Corta	RRP_43	184,00

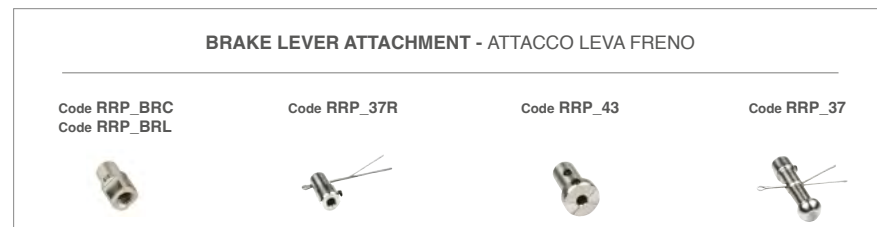

SPARE PARTS REMOTE ADJUSTER - RICAMBI REGISTRO REMOTO

DESCRIPTION - DESCRIZIONE	CODE - CODICE	€
Bracelet + joint for remote adjuster racing - Bracciale + Snodo per registro remoto racing	REGBR	117,00
Bracelet + joint for remote adjuster standard - Bracciale + Snodo per registro remoto standard	REGBS	79,00
Knob for remote adjuster - Pomello per registro remoto	REGPO	28,00
Knob for remote adjuster Racing - Pomello per registro remoto Racing	RRP4	36,00
Short cable (52,5cm) for remote adjuster - Cavo corto (52,5cm) per registro remoto	REGCC	12,00
Long cable (77,5cm) for remote adjuster - Cavo lungo (77,5cm) per registro remoto	REGCL	12,00
Adjuster connection for Bonamici levers - Attacco registro remoto per leve Bonamici	00BRA	18,00
Adjuster connection for Brembo OEM - Attacco registro remoto per Brembo di serie	0037A	34,00
Adjuster connection for Brembo 16x18 - 19x18 - 19x20 Attacco registro remoto per Brembo 16x18 - 19x18 - 19x20	0037RA	18,00
Adjuster connection for Brembo RCS - Attacco registro remoto per Brembo RCS	0043RA	28,00
Adjuster connection for Discacciati / PT / Braking Attacco registro remoto per Discacciati / PT / Braking	0038A	18,00

LEVERS ACCESSORIES AND SPARE PARTS - ACCESSORI E RICAMBI LEVE

The entire Bonamici Racing lever range is supplied with the half lever in the "standard" version in black. When purchasing it is possible to request the lever in different colors at no extra charge and laser engraving as an option.

The levers in the "Straight" version code LL03 and in the "Racing" version code LL04 can be purchased separately as spare parts and are only available in black.

LEVERS ACCESSORIES - ACCESSORI LEVE

DESCRIPTION - DESCRIZIONE	COLOUR- COLORE	CODE - CODICE	€
Colour for Bonamici Racing levers kit Colore per kit leve Bonamici Racing	blue - blu	KLC_BL	-
Colour for Bonamici Racing levers kit Colore per kit leve Bonamici Racing	green - verde	KLC_GR	-
Colour for Bonamici Racing levers kit Colore per kit leve Bonamici Racing	gold - oro	KLC_GO	-
Colour for Bonamici Racing levers kit Colore per kit leve Bonamici Racing	orange - arancio	KLC_OR	-
Colour for Bonamici Racing levers kit Colore per kit leve Bonamici Racing	red - rosso	KLC_RE	-
Colour for Bonamici Racing levers kit Colore per kit leve Bonamici Racing	silver - argento	KLC_SI	-
Colour for Bonamici Racing levers kit Colore per kit leve Bonamici Racing	bronze - bronzo	KLC_BR	-

DESCRIPTION - DESCRIZIONE	COLOUR- COLORE	CODE - CODICE	€
Color for Bonamici Racing single lever Colore per leva singola Bonamici Racing	blue - blu	LLC_BL	-
Color for Bonamici Racing single lever Colore per leva singola Bonamici Racing	green - verde	LLC_GR	-
Color for Bonamici Racing single lever Colore per leva singola Bonamici Racing	gold - oro	LLC_GO	-
Color for Bonamici Racing single lever Colore per leva singola Bonamici Racing	orange - arancio	LLC_OR	-
Color for Bonamici Racing single lever Colore per leva singola Bonamici Racing	red - rosso	LLC_RE	-
Color for Bonamici Racing single lever Colore per leva singola Bonamici Racing	silver - argento	LLC_SI	-
Color for Bonamici Racing single lever Colore per leva singola Bonamici Racing	bronze - bronzo	LLC_BR	-

LEVERS SPARE PARTS - RICAMBI LEVE

DESCRIPTION - DESCRIZIONE	COLOUR- COLORE	CODE - CODICE	€
Aluminium half lever "Standard"(RH/LH) Leva in alluminio "Standard"(DX/SX)	black - nero	LL05_BK	66,00
Aluminium half lever "Standard"(RH/LH) Leva in alluminio "Standard"(DX/SX)	blue - blu	LL05_BL	66,00
Aluminium half lever "Standard"(RH/LH) Leva in alluminio "Standard"(DX/SX)	green - verde	LL05_GR	66,00
Aluminium half lever "Standard"(RH/LH) Leva in alluminio "Standard"(DX/SX)	gold - oro	LL05_GO	66,00
Aluminium half lever "Standard"(RH/LH) Leva in alluminio "Standard"(DX/SX)	orange - arancio	LL05_OR	66,00
Aluminium half lever "Standard"(RH/LH) Leva in alluminio "Standard"(DX/SX)	red - rosso	LL05_RE	66,00
Aluminium half lever "Standard"(RH/LH) Leva in alluminio "Standard"(DX/SX)	silver - argento	LL05_SI	66,00
Aluminium half lever "Standard"(RH/LH) Leva in alluminio "Standard"(DX/SX)	bronze - bronzo	LL05_BR	66,00

L'intera gamma leve Bonamici Racing è fornita con la parte finale della leva nella versione "Standard" di colore nero, al momento dell'acquisto è possibile richiedere la leva in diversi colori senza sovrapprezzo ed incisione laser come optional.

Le leve nella versione "Dritta" codice LL03 e nella versione "Racing" codice LL04 sono acquistabili separatamente come ricambio e disponibili solo di colore nero.



Colour for half lever - Colore parte finale leve

DESCRIPTION - DESCRIZIONE	CODE - CODICE	€
Laser engraving (single lever) - Incisione laser (leva singola)	KLS1	20,00
Laser engraving (levers kit) - Incisione laser (kit leve)	KLS2	30,00
Aluminium stand for levers - Espositore leve in Alluminio	EX02	50,00

DESCRIPTION - DESCRIZIONE	COLOUR- COLORE	CODE - CODICE	€
Aluminium half lever "Straight" (RH/LH) Leva in alluminio "Dritta"(DX/SX)	black - nero	LL03_BK	66,00

DESCRIPTION - DESCRIZIONE	COLOUR- COLORE	CODE - CODICE	€
Aluminium half lever "Racing"(RH/LH) Leva in alluminio "Racing"(DX/SX)	black - nero	LL04_BK	88,00

Note on Colored Anodized Components - Nota sui componenti anodizzati colorati p.148

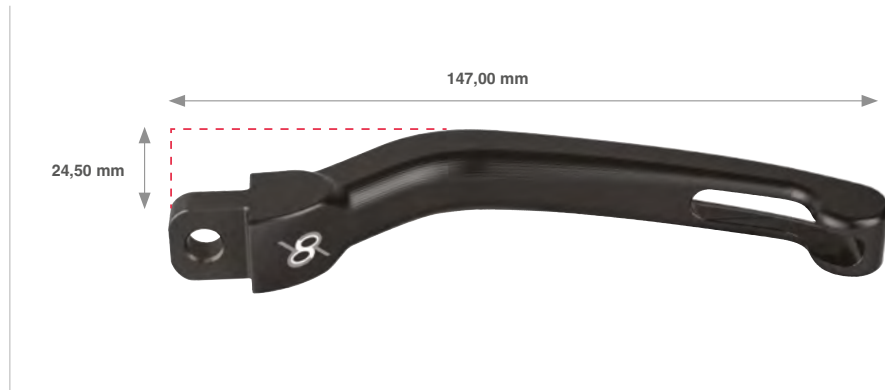

Aluminium half lever "Standard" (RH/LH) - Leva in alluminio "Standard"(DX/SX) - cod. LL05



Blue aluminium half lever "Standard" - code LL05_BL



Aluminium half lever "Straight"(RH/LH) - Leva in alluminio "Dritta" (DX/SX) - cod. LL03



Red aluminium half lever "Straight" - code LL03_BK



Aluminium half lever "Racing" (RH/LH) Leva in alluminio "Racing" (DX/SX) - cod. LL04



Black aluminium half lever "Racing" - code LL04_BK

LEVER PROTECTIONS - PROTEZIONE LEVE



EVO LEVER PROTECTION

In 2013 Bonamici Racing launched on the market its first ever lever-guard completely made of billet aluminum, a product destined to set standards and which over the years will have numerous imitation attempts. After 10 years Bonamici Racing expresses a new concept of lever-guard, through a natural evolution of the product it improves and perfects it from all points of view.

The reduced weight and high structural rigidity mark a new record for the product category. These results were obtained thanks to careful design, the use of special aluminum alloys for aeronautical use with certified quality, together with solid machining with latest generation CNC machinery.

A careful ergonomic study makes the product safe during use, the particular profile of the lever guard minimizes the risk incurred during a possible fall, allowing easy release of the hand from the handlebar.

Various types of adapters with titanium screws are available for fixing, designed so that the distance from the lever can be adjusted with a range of +10mm -10mm.

The entire surface is treated with galvanic anodization protection available in various colors. All this gives life to a lever guard with curvy and eye-catching shapes, with minimal aerodynamic drag obtained through the use of fluid dynamics simulation software.

A design product in full respect of the true "Made in Italy" tradition.

EVO LEVER PROTECTIONS - PROTEZIONE LEVE EVO

DESCRIPTION - DESCRIZIONE	COLOUR - COLORE	CODE - CODICE	€
Right side (without adaptor) - Lato destro (senza adattatore)	black - nero	LPRR2_BK	199,00
Right side (without adaptor) - Lato destro (senza adattatore)	blue - blu	LPRR2_BL	199,00
Right side (without adaptor) - Lato destro (senza adattatore)	bronze - bronzo	LPRR2_BR	199,00
Right side (without adaptor) - Lato destro (senza adattatore)	gold - oro	LPRR2_GO	199,00
Right side (without adaptor) - Lato destro (senza adattatore)	green - verde	LPRR2_GR	199,00
Right side (without adaptor) - Lato destro (senza adattatore)	orange - arancio	LPRR2_OR	199,00
Right side (without adaptor) - Lato destro (senza adattatore)	red - rosso	LPRR2_RE	199,00
Right side (without adaptor) - Lato destro (senza adattatore)	silver - argento	LPRR2_SI	199,00

DESCRIPTION - DESCRIZIONE	COLOUR - COLORE	CODE - CODICE	€
Left side (without adaptor) - Lato sinistro (senza adattatore)	black - nero	LPRL2_BK	199,00
Left side (without adaptor) - Lato sinistro (senza adattatore)	blue - blu	LPRL2_BL	199,00
Left side (without adaptor) - Lato sinistro (senza adattatore)	bronze - bronzo	LPRL2_BR	199,00
Left side (without adaptor) - Lato sinistro (senza adattatore)	gold - oro	LPRL2_GO	199,00
Left side (without adaptor) - Lato sinistro (senza adattatore)	green - verde	LPRL2_GR	199,00
Left side (without adaptor) - Lato sinistro (senza adattatore)	orange - arancio	LPRL2_OR	199,00
Left side (without adaptor) - Lato sinistro (senza adattatore)	red - rosso	LPRL2_RE	199,00
Left side (without adaptor) - Lato sinistro (senza adattatore)	silver - argento	LPRL2_SI	199,00

Note on Colored Anodized Components - Nota sui componenti anodizzati colorati p.148

PROTEZIONE LEVE EVO

Nel 2013 Bonamici Racing lancia sul mercato il primo paraleva in assoluto completamente in alluminio ricavato dal pieno, un prodotto destinato a far scuola e che negli anni avrà numerosi tentativi di imitazione. Dopo 10 anni Bonamici Racing esprime un nuovo concetto di paraleva, attraverso una naturale evoluzione del prodotto lo migliora e lo perfeziona sotto tutti i punti di vista.

Il peso ridotto e l'elevata rigidità strutturale segnano un nuovo record per la categoria di prodotto. Questi risultati sono stati ottenuti grazie ad un'accurata progettazione, all'impiego di speciali leghe di alluminio d'uso aeronautico con qualità certificata, unitamente alla lavorazione dal pieno con macchinari CNC d'ultima generazione.

Un attento studio d'ergonomia rende il prodotto sicuro durante l'utilizzo, il particolare profilo del paraleva riduce al minimo il rischio che si corre durante un'eventuale caduta, permettendo un agevole svincolo della mano dal manubrio.

Per il fissaggio sono disponibili vari tipi di adattatori con viti in titanio, progettati in modo da poter regolare la distanza dalla leva con un range di +10mm -10mm.

Tutta la superficie è trattata con protezione galvanica di anodizzazione disponibile in vari colori. Tutto questo dà vita ad un paraleva dalle forme sinuose ed accattivanti, dal minimo attrito aerodinamico ottenuto mediante l'uso di software di simulazione della fluidodinamica.

Un prodotto di design nel pieno rispetto della tradizione del vero "Made in Italy".

LEVER PROTECTIONS - PROTEZIONE LEVE

EVO LEVER PROTECTIONS - PROTEZIONE LEVE EVO

ADAPTORS - ADATTATORI

DESCRIPTION - DESCRIZIONE	CODE - CODICE	€
for Bonamici Racing bars tube - per tubi manubrio Bonamici Racing	ADLT_U	31,00
from ø13mm to ø 14mm tube - per tubo da ø13mm a ø14mm	ADL13_U	31,00
from ø14mm to ø 15mm tube - per tubo da ø14mm a ø15mm	ADL14_U	31,00
from ø15mm to ø 16mm tube - per tubo da ø15mm a ø16mm	ADL15_U	31,00
from ø16mm to ø 17mm tube - per tubo da ø16mm a ø17mm	ADL16_U	31,00
from ø17mm to ø 18mm tube - per tubo da ø17mm a ø18mm	ADL17_U	31,00
from ø18mm to ø 19mm tube - per tubo da ø18mm a ø19mm	ADL18_U	31,00
from ø19mm to ø 20mm tube - per tubo da ø19mm a ø20mm	ADL19_U	31,00
from ø20mm to ø 21mm tube - per tubo da ø20mm a ø21mm	ADL20_U	31,00
Aprilia RS 660	ADL660_U	31,00
Aprilia RSV4/RSV4 Factory (2009/2024)	ADLA_U	31,00
BMW S 1000 RR (2008-2018)	ADLB_U	31,00
BMW S 1000 RR (2019-2025)	ADLRR_U	31,00
Ducati Panigale V4	ADL17_U	31,00
Ducati Panigale V2	ADLT_U	31,00
Ducati Streetfighter V2	ADLSV2_U	31,00
Ducati Streetfighter V4/V4S (2025/2025)	ADL13_U	31,00
Honda CBR1000RR-R Fireblade (2020/2025)	ADLH19_U	31,00
Honda CBR 1000 RR (2008/2016)	ADLH19_U	31,00
Honda CBR 600 RR	ADLH19_U	31,00
Kawasaki ZX-10R (2021/2025)	ADLZX_U	31,00
Kawasaki Ninja 400	ADLRR_U	31,00
Kawasaki ZX-4R/RR (2023/2025)	ADL4R_U	31,00
Kawasaki ZX-6R (2024/2025)	ADLZX_U	31,00
Kawasaki Z 900	ADL4R_U	31,00
KTM 1290 Super Duke R (2020/2023) - KTM 1390 Super Duke R (2024/2025)	ADL13_U	31,00
MV Agusta F3 675/800	ADL18_U	31,00
MV Agusta F4	ADL16_U	31,00
MV Agusta Brutale 675/800	ADL14_U	31,00
Suzuki GSX-R 1000 (2017/2025)	ADLRR_U	31,00
Suzuki GSX-8S/8R (2023/2025)	ADLS_U	31,00
Triumph Speed Triple 1200 RS	ADL660_U	31,00
Triumph Speed Triple 1200 RR	ADLST_U	31,00
Triumph Street Triple 765 R/RS/RS Moto2 (2023/2025)	ADL765_U	31,00
Yamaha YZF R1 (1998/2025)	ADLY_U	31,00
Yamaha YZF R3 (2015/2025)	ADLY_U	31,00
Yamaha YZF R6 (2006/2025)	ADLY_U	31,00
Yamaha YZF R7 (2021/2025)	ADLY_U	31,00
Yamaha YZF R9 (2025/2025)	ADLY_U	31,00
Yamaha MT-09 (2021/2025)	ADLY_U	31,00



LEVER PROTECTIONS - PROTEZIONE LEVE

CARBON LEVER PROTECTION

Made of fine carbon fiber, 100% made in Italy, extremely detailed both internal and external surfaces, it guarantees maximum strength and low weight.

This new particular design has been studied in detail through aerodynamics and fluid dynamics studies to reduce the air pressure both on the lever guard itself and on the brake command at high speeds.

The new design of the lever guard has been created to favor a wide movement of the hand and wrist in the various riding phases and also to facilitate the rapid release of the hand in the event of a fall or accident. In addition to being a fundamental element for safety, the Bonamici Racing carbon shift guard is a real design object that gives the bike a very beautiful and sporty look.

The peculiarity of the new carbon lever guard is that it is supplied with a titanium screw and it is possible to adjust its position both in the longitudinal axis and in the transversal axis thanks to a new bushing system mounted between the handlebar and the lever guard itself. One of a kind, perfect for Bonamici Racing Clip-ons. For other uses, we recommend consulting the adapter list and requesting the most suitable one for your motorcycle model.

PROTEZIONE LEVA IN CARBONIO

Realizzata in pregiata fibra di carbonio, 100% made in Italy, estremamente dettagliata in entrambe le superfici interna ed esterna, garantisce massima robustezza e peso contenuto. Questo nuovo particolare design è stato studiato nei minimi dettagli attraverso studi di aerodinamica e fluidodinamica per ridurre la pressione dell'aria sia sul paraleva stesso che sul comando del freno alle alte velocità.

Il nuovo design del paraleva è stato realizzato per favorire un ampio movimento della mano e del polso nelle varie fasi di guida e anche per facilitare il rapido rilascio della mano in caso di caduta o incidente. Oltre ad essere un elemento fondamentale per la sicurezza, il paraleva in carbonio Bonamici Racing è un vero e proprio oggetto di design che dona alla moto un aspetto molto bello e sportivo.

La particolarità del nuovo paraleva in carbonio è che viene fornito con vite in titanio ed è possibile aggiustarne la posizione sia in asse longitudinale sia in asse trasversale grazie ad un nuovo sistema a boccia montato tra il manubrio ed il paraleva stesso. Unico nel suo genere, perfetto per semimanubri Bonamici Racing, per altri usi consigliamo di consultare l'elenco adattatori e richiedere quello più adatto al vostro modello di moto.



CARBON LEVER PROTECTIONS - PROTEZIONE LEVE IN CARBONIO

DESCRIPTION - DESCRIZIONE	CODE - CODICE	€
Right side (without adaptor) - Lato destro (senza adattatore)	LPLITE1_R	251,00

ADAPTORS - ADATTATORI

DESCRIPTION - DESCRIZIONE	CODE - CODICE	€
for Bonamici Racing bars tube - per tubi manubrio Bonamici Racing	ADLT_U	31,00
from ø13mm to ø 14mm tube - per tubo da ø13mm a ø14mm	ADL13_U	31,00
from ø14mm to ø 15mm tube - per tubo da ø14mm a ø15mm	ADL14_U	31,00
from ø15mm to ø 16mm tube - per tubo da ø15mm a ø16mm	ADL15_U	31,00
from ø16mm to ø 17mm tube - per tubo da ø16mm a ø17mm	ADL16_U	31,00
from ø17mm to ø 18mm tube - per tubo da ø17mm a ø18mm	ADL17_U	31,00
from ø18mm to ø 19mm tube - per tubo da ø18mm a ø19mm	ADL18_U	31,00
from ø19mm to ø 20mm tube - per tubo da ø19mm a ø20mm	ADL19_U	31,00
from ø20mm to ø 21mm tube - per tubo da ø20mm a ø21mm	ADL20_U	31,00
Aprilia RS 660	ADL660_U	31,00
Aprilia RSV4/RSV4 Factory (2009/2024)	ADLA_U	31,00
BMW S 1000 RR (2008-2018)	ADLB_U	31,00
BMW S 1000 RR (2019-2025)	ADLRR_U	31,00
Ducati Panigale V4	ADL17_U	31,00
Ducati Panigale V2	ADLT_U	31,00
Ducati Streetfighter V2	ADLSV2_U	31,00
Ducati Streetfighter V4/V4S (2025/2025)	ADL13_U	31,00
Honda CBR1000RR-R Fireblade (2020/2025)	ADLH19_U	31,00
Honda CBR 1000 RR (2008/2016)	ADLH19_U	31,00
Honda CBR 600 RR	ADLH19_U	31,00
Kawasaki ZX-10R (2021/2025)	ADLZX_U	31,00
Kawasaki Ninja 400	ADLRR_U	31,00
Kawasaki ZX-4R/RR (2023/2025)	ADL4R_U	31,00
Kawasaki ZX-6R (2024/2025)	ADLZX_U	31,00
Kawasaki Z 900	ADL4R_U	31,00
KTM 1290 Super Duke R (2020/2023) - KTM 1390 Super Duke R (2024/2025)	ADL13_U	31,00
MV Agusta F3 675/800	ADL18_U	31,00
MV Agusta F4	ADL16_U	31,00
MV Agusta Brutale 675/800	ADL14_U	31,00
Suzuki GSX-R 1000 (2017/2025)	ADLRR_U	31,00
Suzuki GSX-8S/8R (2023/2025)	ADLS_U	31,00
Triumph Speed Triple 1200 RS	ADL660_U	31,00
Triumph Speed Triple 1200 RR	ADLST_U	31,00
Triumph Street Triple 765 R/RS/RS Moto2 (2023/2025)	ADL765_U	31,00
Yamaha YZF R1 (1998/2025)	ADLY_U	31,00
Yamaha YZF R3 (2015/2025)	ADLY_U	31,00
Yamaha YZF R6 (2006/2025)	ADLY_U	31,00
Yamaha YZF R7 (2021/2025)	ADLY_U	31,00
Yamaha YZF R9 (2025/2025)	ADLY_U	31,00
Yamaha MT-09 (2021/2025)	ADLY_U	31,00



LEVER PROTECTIONS - PROTEZIONE LEVE



ALUMINUM LEVER PROTECTIONS - PROTEZIONE LEVE IN ALLUMINIO

DESCRIPTION - DESCRIZIONE	COLOUR - COLORE	CODE - CODICE	€
Right side (without adaptor) - Lato destro (senza adattatore)	black - nero	LPRR_B_BK	111,00
Right side (without adaptor) - Lato destro (senza adattatore)	blue - blu	LPRR_B_BL	111,00
Right side (without adaptor) - Lato destro (senza adattatore)	bronze - bronzo	LPRR_B_BR	111,00
Right side (without adaptor) - Lato destro (senza adattatore)	gold - oro	LPRR_B_GO	111,00
Right side (without adaptor) - Lato destro (senza adattatore)	green - verde	LPRR_B_GR	111,00
Right side (without adaptor) - Lato destro (senza adattatore)	orange - arancio	LPRR_B_OR	111,00
Right side (without adaptor) - Lato destro (senza adattatore)	red - rosso	LPRR_B_RE	111,00
Right side (without adaptor) - Lato destro (senza adattatore)	silver - argento	LPRR_B_SI	111,00

Left side (without adaptor) - Lato sinistro (senza adattatore)	black - nero	LPRL_B_BK	111,00
Left side (without adaptor) - Lato sinistro (senza adattatore)	blue - blu	LPRL_B_BL	111,00
Left side (without adaptor) - Lato sinistro (senza adattatore)	bronze - bronzo	LPRL_B_BR	111,00
Left side (without adaptor) - Lato sinistro (senza adattatore)	gold - oro	LPRL_B_GO	111,00
Left side (without adaptor) - Lato sinistro (senza adattatore)	green - verde	LPRL_B_GR	111,00
Left side (without adaptor) - Lato sinistro (senza adattatore)	orange - arancio	LPRL_B_OR	111,00
Left side (without adaptor) - Lato sinistro (senza adattatore)	red - rosso	LPRL_B_RE	111,00
Left side (without adaptor) - Lato sinistro (senza adattatore)	silver - argento	LPRL_B_SI	111,00

Note on Colored Anodized Components - Nota sui componenti anodizzati colorati p.148



LEVER PROTECTIONS - PROTEZIONE LEVE

ADAPTORS - ADATTATORI

DESCRIPTION - DESCRIZIONE	CODE - CODICE	€
for Bonamici Racing bars tube - per tubi manubrio Bonamici Racing	ADLT	31,00
from ø13mm to ø 14mm tube - per tubo da ø13mm a ø14mm	ADL13	31,00
from ø14mm to ø 15mm tube - per tubo da ø14mm a ø15mm	ADL14	31,00
from ø15mm to ø 16mm tube - per tubo da ø15mm a ø16mm	ADL15	31,00
from ø16mm to ø 17mm tube - per tubo da ø16mm a ø17mm	ADL16	31,00
from ø17mm to ø 18mm tube - per tubo da ø17mm a ø18mm	ADL17	31,00
from ø18mm to ø 19mm tube - per tubo da ø18mm a ø19mm	ADL18	31,00
from ø19mm to ø 20mm tube - per tubo da ø19mm a ø20mm	ADL19	31,00
from ø20mm to ø 21mm tube - per tubo da ø20mm a ø21mm	ADL20	31,00
Aprilia RS 660	ADL660	31,00
Aprilia RSV4/RSV4 Factory (2009/2024)	ADLA	31,00
BMW S 1000 RR (2008-2018)	ADLB	31,00
BMW S 1000 RR (2019-2025)	ADLRR	31,00
Ducati Panigale V4	ADL17	31,00
Ducati Panigale V2	ADLT	31,00
Ducati Streetfighter V2	ADLSV2	31,00
Ducati Streetfighter V4/V4S (2025/2025)	ADL13	31,00
Honda CBR1000RR-R Fireblade (2020/2025)	ADLH19	31,00
Honda CBR 1000 RR (2008/2016)	ADLH19	31,00
Honda CBR 600 RR	ADLH19	31,00
Kawasaki ZX-10R (2021/2025)	ADLZX	31,00
Kawasaki Ninja 400	ADLRR	31,00
Kawasaki ZX-4R/RR (2023-2025)	ADL4R	31,00
Kawasaki ZX-6R (2024/2025)	ADLZX	31,00
Kawasaki Z 900	ADL4R	31,00
KTM 1290 Super Duke R (2020/2023) - KTM 1390 Super Duke R (2024/2025)	ADL13	31,00
MV Agusta F3 675/800	ADL18	31,00
MV Agusta F4	ADL16	31,00
MV Agusta Brutale 675/800	ADL14	31,00
Suzuki GSX-R 1000 (2017/2025)	ADLRR	31,00
Suzuki GSX-8S/8R (2023/2025)	ADLS	31,00
Triumph Speed Triple 1200 RS	ADL660	31,00
Triumph Speed Triple 1200 RR	ADLST	31,00
Triumph Street Triple 765 R/RS/RS Moto2 (2023/2025)	ADL765	31,00
Yamaha YZF R1 (1998/2025)	ADLY	31,00
Yamaha YZF R3 (2015/2025)	ADLY	31,00
Yamaha YZF R6 (2006/2025)	ADLY	31,00
Yamaha YZF R7 (2021/2025)	ADLY	31,00
Yamaha YZF R9 (2025/2025)	ADLY	31,00
Yamaha MT-09 (2021/2025)	ADLY	31,00

ACCESSORIES - ACCESSORI

DESCRIPTION - DESCRIZIONE

Lasers engraving **ON REQUEST** - Incisione laser **SU RICHIESTA**

FRONT PEG SPARE PART - PUNTALINO DI RICAMBIO

DESCRIPTION - DESCRIZIONE	COLOUR - COLORE	CODE - CODICE	€
Front peg spare part (right side) - Puntalino di ricambio (lato destro)	black - nero	LPP_DX_BK	45,00
Front peg spare part (right side) - Puntalino di ricambio (lato destro)	blue - blu	LPP_DX_BL	45,00
Front peg spare part (right side) - Puntalino di ricambio (lato destro)	gold - oro	LPP_DX_GO	45,00
Front peg spare part (right side) - Puntalino di ricambio (lato destro)	green - verde	LPP_DX_GR	45,00
Front peg spare part (right side) - Puntalino di ricambio (lato destro)	orange - arancio	LPP_DX_OR	45,00
Front peg spare part (right side) - Puntalino di ricambio (lato destro)	red - rosso	LPP_DX_RE	45,00
Front peg spare part (right side) - Puntalino di ricambio (lato destro)	silver - argento	LPP_DX_SI	45,00
Front peg spare part (right side) - Puntalino di ricambio (lato destro)	bronze - bronzo	LPP_DX_BR	45,00
Front peg spare part (left side) - Puntalino di ricambio (lato sinistro)	black - nero	LPP_SX_BK	45,00
Front peg spare part (left side) - Puntalino di ricambio (lato sinistro)	blue - blu	LPP_SX_BL	45,00
Front peg spare part (left side) - Puntalino di ricambio (lato sinistro)	gold - oro	LPP_SX_GO	45,00
Front peg spare part (left side) - Puntalino di ricambio (lato sinistro)	green - verde	LPP_SX_GR	45,00
Front peg spare part (left side) - Puntalino di ricambio (lato sinistro)	orange - arancio	LPP_SX_OR	45,00
Front peg spare part (left side) - Puntalino di ricambio (lato sinistro)	red - rosso	LPP_SX_RE	45,00
Front peg spare part (left side) - Puntalino di ricambio (lato sinistro)	silver - argento	LPP_SX_SI	45,00
Front peg spare part (left side) - Puntalino di ricambio (lato sinistro)	bronze - bronzo	LPP_SX_BR	45,00

Note on Colored Anodized Components - Nota sui componenti anodizzati colorati p.148



CLIP-ONS - SEMIMANUBRI

Tube for non-raised Clip-ons

Tubo per semimanubrio non rialzato

Tube length - Lunghezza tubo	245 mm
Tube useful length - Lunghezza utilizzabile tubo	225 mm
Outer tube diameter - Diametro esterno tubo	22 mm
Inner tube diameter - Diametro interno tubo	16 mm

Tube for raised Clip-ons

Tubo per semimanubrio rialzato

Tube length - Lunghezza tubo	270 mm
Tube useful length - Lunghezza utilizzabile tubo	235 mm
Outer tube diameter - Diametro esterno tubo	22 mm
Inner tube diameter - Diametro interno tubo	16 mm

NON-RAISED CLIP-ONS SEMIMANUBRI NON RIALZATI



RAISED CLIP-ONS SEMIMANUBRI RIALZATI



WARNING - ATTENZIONE

At the time of purchase it is necessary to choose the ideal diameter, first make sure of the diameter of the front forks of the bike and then choose the right diameter of the Clip-ons.

Al momento dell'acquisto occorre scegliere il diametro ideale, per prima cosa assicurarsi del diametro forcelle anteriori della moto e successivamente scegliere il giusto diametro dei semimanubri.

Bonamici Racing realizes for the major sports bikes, handlebars that allow a sporty driving at the highest levels and a perfect feeling in all conditions.

Two version: raised and not raised, both with inclination of 6,5° degrees. Each element of the Bonamici Racing Clip-ons is made from solid billet aluminium machined with cnc technology.

Bonamici Racing realizza per le maggiori moto sportive semimanubri che consentono una guida sportiva ai massimi livelli e un feeling perfetto in ogni condizione.

Varie versioni, rialzati e non rialzati, entrambi con inclinazione di 6,5° gradi. Ogni elemento del semimanubrio Bonamici Racing è realizzato dal pieno in alluminio billet lavorato con tecnologia cnc



BMW S 1000 RR (2023/2025)
raised Clip-ons / Diameter 55 mm - cod. SM55S1KW

CLIP-ONS - SEMIMANUBRI

DESCRIPTION DESCRIZIONE	OFFSET	HEIGHT RIALZO	SPARE TUBE TUBO DI RICAMBIO	CODE CODICE	€
Diameter 41 mm raised - Diametro 41 mm rialzati	45 mm	15,5 mm	RASM_1	SM41	254,00
Diameter 41 mm raised 28mm - Diametro 41 mm rialzato 28 mm	45 mm	28 mm	RASM_1	SM41_30	267,00
Diameter 45 mm raised - Diametro 45 mm rialzati (Kawasaki ZX-4R/RR 2023-2025)	28 mm	30 mm	RASM_2	SM45A	267,00
Diameter 47 mm raised - Diametro 47 mm rialzati	49 mm	15,5 mm	RASM_1	SM47	267,00
Diameter 48 mm raised - Diametro 48 mm rialzati	49 mm	15,5 mm	RASM_1	SM48	267,00
Diameter 50 mm raised - Diametro 50 mm rialzati	49 mm	15,5 mm	RASM_1	SM50	267,00
Diameter 50 mm raised - Diametro 50 mm rialzati	18 mm	26 mm	RASM_2	SM50A	267,00
Diameter 50 mm raised - Diametro 50 mm rialzati (Suzuki GSX-8R 2023-2025) they include steering stop code BS04 and steering plate caps code TPS01 comprendono battuta di sterzo codice BS04 e tappi piastra di sterzo codice TPS01	18 mm	26 mm	RASM_2	SM50A8R	381,00
Diameter 50 mm non-raised - Diametro 50 mm non rialzati	16 mm	0 mm	RASM_2	SM50B	267,00
Diameter 51 mm raised - Diametro 51 mm rialzati	49 mm	15,5 mm	RASM_1	SM51	267,00
Diameter 51 mm raised - Diametro 51 mm rialzati (Aprilia RS 660) 4 (Aprilia RSV4 2021)	18 mm	26 mm	RASM_2	SM51A	267,00
Diameter 51 mm non-raised - Diametro 51 mm non rialzati	16 mm	0 mm	RASM_2	SM51B	267,00
Diameter 52 mm raised - Diametro 52 mm rialzati	51,5 mm	15,5 mm	RASM_1	SM52	267,00
Diameter 52 mm non-raised - Diametro 52 mm non rialzati	16 mm	0 mm	RASM_2	SM52B	267,00
Diameter 53 mm raised - Diametro 53 mm rialzati	51,5 mm	15,5 mm	RASM_1	SM53	267,00
Diameter 53 mm non-raised - Diametro 53 mm non rialzati	16 mm	0 mm	RASM_2	SM53B	267,00
Diameter 53 mm non-raised - Diametro 53 mm non rialzati (Ducati 1199S Panigale) 1	16 mm	0 mm	RASM_2	SM53PA	328,00
Diameter 53 mm non-raised - Diametro 53 mm non rialzati (Panigale V2 2020-2024) 1	40 mm	0 mm	RASM_2	SM53PV2	328,00
Diameter 53 mm non-raised - Diametro 53 mm non rialzati (Ducati Panigale V4/V4S 2018-2024) 1	40mm	0 mm	RASM_2	SM53PV4	343,00
Diameter 53 mm non-raised - Diametro 53 mm non rialzati (Ducati Panigale V4R 2018-2024) 1	40 mm	0 mm	RASM_2	SM53PV4R	343,00
Diameter 53 mm non-raised - Diametro 53 mm non rialzati (Ducati Panigale V4/V4S 2025) 1	40mm	0 mm	RASM_2	SM53C_V4	343,00
Diameter 55 mm raised - Diametro 55 mm rialzati	51,5 mm	15,5 mm	RASM_1	SM55	267,00
Diameter 55 mm non-raised - Diametro 55 mm non rialzati 2	18 mm	0 mm	RASM_2	SM55B	267,00
Diameter 55 mm raised - Diametro 55 mm rialzati 3 (BMW S 1000 RR / M 1000 RR '19/2025)	18 mm	27 mm	RASM_2	SM55S1K	391,00
Diameter 55 mm raised - Diametro 55 mm rialzati 2 (BMW S 1000 RR / M 1000 RR '19/2025)	18 mm	27 mm	RASM_2	SM55S1KW	267,00
Diameter 55 mm non-raised - Diametro 55 mm non rialzati (BMW S 1000 RR / M 1000 RR '19/2025)	18 mm	0 mm	RASM_2	SM55BS1K	391,00
Steering stops - Coppia battute di sterzo (Aprilia RS 660)				BS02	69,00
Steering stop - Battuta di sterzo (Suzuki GSX-8R)				BS04	69,00



Diameter 53 mm Non-Raised
Diametro 53 mm (Ducati Panigale V4/V4S 2025)- cod. SM53C_V4



Diameter 55 mm raised
Diametro 55 mm (BMW S 1000 RR '19/25) - cod. SM55S1K

CLIP-ONS SPARE PARTS - RICAMBI SEMIMANUBRI

DESCRIPTION - DESCRIZIONE	CODE - CODICE	€
Clamps for OEM steering plate (BMW S 1000 RR - M 1000 RR '19 / 2025) Coppia di supporti ad arco per piastra di sterzo originale (BMW S 1000 RR - M 1000 RR '19/ 2025)	BMRS1K	124,00
Pair of balancers for SM55S1K/SM55B - Coppia contrappesi per SM55S1K/SM55B	ADLS1K_2	105,00
Spare bracket right side - Bracciale di ricambio lato DX	BMRD	103,00
Spare bracket left side - Bracciale di ricambio lato SX	BMRS	103,00
Spare tube for raised Clip-ons (Tube length 270 mm - Tube useful length 235 mm) Tubo di ricambio per semimanubri rialzati (Lunghezza tubo 270 mm - Lunghezza utilizzabile 235mm)	RASM_1	48,00
Spare tube for non-raised Clip-ons (Tube length 245 mm - Tube useful length 225 mm) Tubo ricambio per semimanubri non rialzati (Lunghezza tubo 245 mm - Lunghezza utilizzabile 225mm)	RASM_2	48,00
Tube cap (end cap) - Tappo tubo (tappo finale)	TASM_2	10,00
Bracket for steering damper - Bracciale ammortizzatore di sterzo	BAMS	69,00
Bracket for steering damper - Bracciale ammortizzatore di sterzo (Ducati Panigale V4 2025)	BAMS_53C	69,00
Steering plate caps for Suzuki GSX-8R - Tappi piastra di sterzo per Suzuki GSX-8R	TPS01	44,00

WARNING - ATTENZIONE

- Include the bracket for steering damper
• Include il bracciale per l'ammortizzatore di sterzo
- Clip-ons to use the OEM triple clamp (include the clamps for steering plate) - Spare tube code RASM_2
• Semimanubri utilizzabili con la piastra di sterzo originale (Include la coppia di supporti ad arco per la piastra di sterzo)
Tubo di ricambio cod. RASM_2
- Clip-ons to use with Bonamici Racing top triple clamp (not include the clamps for steering plate) - Spare tube code RASM_2
• Semimanubri utilizzabili con la piastra di sterzo Bonamici Racing (non Include la coppia di supporti ad arco per la piastra di sterzo)
Tubo di ricambio cod. RASM_2
- We recommend purchasing the steering stops code - BS02
• Consigliamo l'acquisto delle battute di sterzo codice - BS02

MEASUREMENT SCHEME - SCHEMA MISURE

- Height means the distance between bracelet center / tube axis
- Offset means the distance between fork axis / tube axis
- Per Rialzo si intende la distanza tra centro bracciale / asse tubo
- Per Offset si intende la distanza tra asse forcella / asse tubo

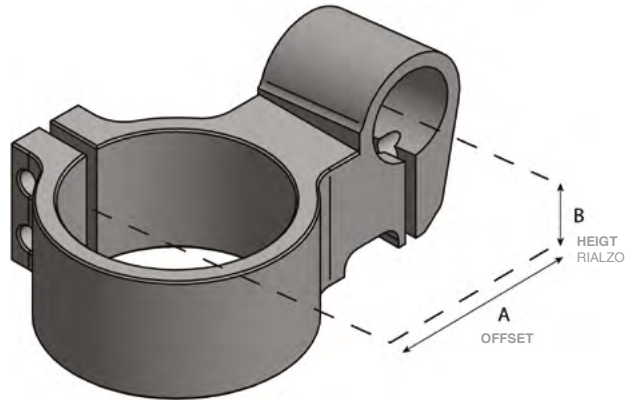

OFFSET

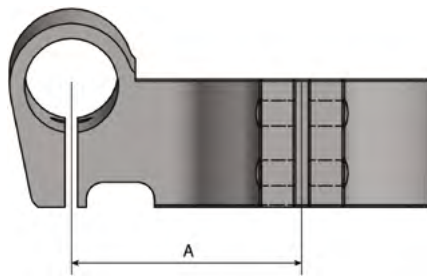

HEIGHT - RIALZO

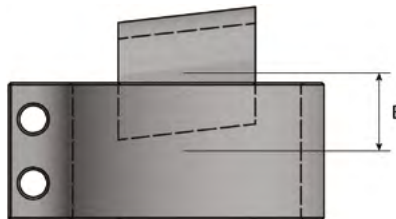

Ducati Panigale V4 2025
Non-Raised clip-ons / Diameter 53 mm - cod. SM53C_V4

CHAIN ADJUSTER - TENDICATENA



Made of Ergal machined from solid with CNC technology, the Bonamici Racing chain adjuster is robust and effective, with the use of bearings to completely eliminate friction and for the first time with adjustable micrometric system. It is possible to customize the inner part in various colors, while the outer part is only available in black color

Realizzato in Ergal ricavato dal pieno con tecnologia CNC, il tendicatena Bonamici Racing è robusto ed efficace, con l'uso di cuscinetti per eliminare completamente l'attrito e le posizioni regolabili micrometricamente. È possibile la personalizzazione in vari colori per la parte interna, mentre la parte esterna è disponibile solo di colore nero

CHAIN ADJUSTER - TENDICATENA

BRAND	MODEL - MODELLO	FROM - DAL	TO - AL	COLOUR- COLORE	CODE - CODICE	€
Aprilia	RS 660/Tuono 660	2020	2025	black - nero	CHAD12_BK	274,00
Aprilia	RS 660/Tuono 660	2020	2025	blue - blu	CHAD12_BL	274,00
Aprilia	RS 660/Tuono 660	2020	2025	gold - oro	CHAD12_GO	274,00
Aprilia	RS 660/Tuono 660	2020	2025	red - rosso	CHAD12_RE	274,00
Aprilia	RS 660/Tuono 660	2020	2025	silver - argento	CHAD12_SI	274,00
Aprilia	RSV4/Tuono V4	2015	2020	black - nero	CHAD04_BK	274,00
Aprilia	RSV4/Tuono V4	2015	2020	blue - blu	CHAD04_BL	274,00
Aprilia	RSV4/Tuono V4	2015	2020	gold - oro	CHAD04_GO	274,00
Aprilia	RSV4/Tuono V4	2015	2020	red - rosso	CHAD04_RE	274,00
Aprilia	RSV4/Tuono V4	2015	2020	silver - argento	CHAD04_SI	274,00
Aprilia	RSV4/RSV4 Factory/Tuono V4	2021	2024	black - nero	CHAD13_BK	274,00
Aprilia	RSV4/RSV4 Factory/Tuono V4	2021	2024	blue - blu	CHAD13_BL	274,00
Aprilia	RSV4/RSV4 Factory/Tuono V4	2021	2024	gold - oro	CHAD13_GO	274,00
Aprilia	RSV4/RSV4 Factory/Tuono V4	2021	2024	red - rosso	CHAD13_RE	274,00
Aprilia	RSV4/RSV4 Factory/Tuono V4	2021	2024	silver - argento	CHAD13_SI	274,00
BMW	S 1000 RR	2008	2018	black - nero	CHAD01_BK	274,00
BMW	S 1000 RR	2008	2018	blue - blu	CHAD01_BL	274,00
BMW	S 1000 RR	2008	2018	gold - oro	CHAD01_GO	274,00
BMW	S 1000 RR	2008	2018	red - rosso	CHAD01_RE	274,00
BMW	S 1000 RR	2008	2018	silver - argento	CHAD01_SI	274,00
BMW	S 1000 RR	2019	2025	black - nero	CHAD09_BK	274,00
BMW	S 1000 RR	2019	2025	blue - blu	CHAD09_BL	274,00
BMW	S 1000 RR	2019	2025	gold - oro	CHAD09_GO	274,00
BMW	S 1000 RR	2019	2025	red - rosso	CHAD09_RE	274,00
BMW	S 1000 RR	2019	2025	silver - argento	CHAD09_SI	274,00
BMW	S 1000 R	2012	2020	black - nero	CHAD01_BK	274,00
BMW	S 1000 R	2012	2020	blue - blu	CHAD01_BL	274,00
BMW	S 1000 R	2012	2020	gold - oro	CHAD01_GO	274,00
BMW	S 1000 R	2012	2020	red - rosso	CHAD01_RE	274,00
BMW	S 1000 R	2012	2020	silver - argento	CHAD01_SI	274,00
BMW	S 1000 R - M 1000 R	2021	2025	black - nero	CHAD09_BK	274,00
BMW	S 1000 R - M 1000 R	2021	2025	blue - blu	CHAD09_BL	274,00
BMW	S 1000 R - M 1000 R	2021	2025	gold - oro	CHAD09_GO	274,00
BMW	S 1000 R - M 1000 R	2021	2025	red - rosso	CHAD09_RE	274,00
BMW	S 1000 R - M 1000 R	2021	2025	silver - argento	CHAD09_SI	274,00
BMW	S 1000 XR*	2020	2025	black - nero	CHAD15_BK	317,00
BMW	S 1000 XR*	2020	2025	blue - blu	CHAD15_BL	317,00
BMW	S 1000 XR*	2020	2025	gold - oro	CHAD15_GO	317,00
BMW	S 1000 XR*	2020	2025	red - rosso	CHAD15_RE	317,00
BMW	S 1000 XR*	2020	2025	silver - argento	CHAD15_SI	317,00
Honda	CBR 1000 RR	2008	2016	black - nero	CHAD14_BK	274,00
Honda	CBR 1000 RR	2008	2016	blue - blu	CHAD14_BL	274,00
Honda	CBR 1000 RR	2008	2016	gold - oro	CHAD14_GO	274,00
Honda	CBR 1000 RR	2008	2016	red - rosso	CHAD14_RE	274,00
Honda	CBR 1000 RR	2008	2016	silver - argento	CHAD14_SI	274,00
Honda	CBR 600 RR	2024	2025	black - nero	CHAD14_BK	274,00
Honda	CBR 600 RR	2024	2025	blue - blu	CHAD14_BL	274,00
Honda	CBR 600 RR	2024	2025	gold - oro	CHAD14_GO	274,00
Honda	CBR 600 RR	2024	2025	red - rosso	CHAD14_RE	274,00
Honda	CBR 600 RR	2024	2025	silver - argento	CHAD14_SI	274,00

* Chain adjuster with integrated EVO standard swingarms spools - Tendicatena con supporto cavalletto standard EVO integrato

Note on Colored Anodized Components - Nota sui componenti anodizzati colorati p.148



CHAIN ADJUSTER FOR BMW S 1000 XR Code CHAD15

Chain adjuster with integrated EVO standard swingarms spools, coordinated with the internal adjuster color and specifically designed for the BMW S 1000 XR.

This innovative solution combines the precision of a reliable and adjustable chain adjuster system with the practicality of an integrated EVO swingarms spools, ideal for simplifying maintenance operations and parking the motorcycle on a racing stand. Made from aerospace aluminum and machined with the latest CNC technology, this chain adjuster offers maximum strength and durability even in the most challenging conditions. In addition to enhancing functionality, the elegant and minimalist design adds a stylish touch to the BMW S1000 XR, maintaining the motorcycle's bold and modern aesthetics. Perfect for those seeking a combination of performance, practicality, and quality Made in Italy.



TENDICATENA PER BMW S 1000 XR Codice CHAD15

Tendicatena con supporto cavalletto standard EVO integrato, coordinato con il colore del registro interno e progettato specificamente per la BMW S 1000 XR.

Una soluzione innovativa combina la precisione di un sistema di tensionamento della catena affidabile e regolabile con la praticità del supporto cavalletto EVO integrato, ideale per semplificare le operazioni di manutenzione e parcheggio della moto su cavalletto racing. Realizzato in alluminio aeronautico e lavorato con macchinari CNC di ultima generazione, questo tendicatena offre massima resistenza e durata anche nelle condizioni più impegnative. Oltre a migliorare la funzionalità, il design elegante e minimale aggiunge un tocco di stile alla BMW S1000 XR, mantenendo l'estetica grintosa e moderna della moto. Perfetto per chi cerca una combinazione di performance, praticità e qualità Made in Italy.

CHAIN ADJUSTER - TENDICATENA



CHAIN ADJUSTER WITH CALIPER SUPPORT

Chain adjuster with caliper support by Bonamici Racing, is a solution that combines advanced functionality and practicality, available with the internal adjuster exclusively in black.

This accessory not only allows precise adjustment of the chain adjuster but also integrates a caliper support, providing an important advantage: it ensures the correct positioning of the rear brake caliper during adjustment and wheel change, preventing unwanted movement and simplifying maintenance operations.

Made from durable aeronautics aluminum and machined with high-precision CNC technology, this chain adjuster with caliper support guarantees robustness and longevity, perfect for those seeking professional quality solutions for enhance their riding and maintenance experience.

TENDICATENA CON SUPPORTO PINZA

Tendicatena con supporto pinza di Bonamici Racing, è una soluzione che unisce funzionalità avanzata e praticità, disponibile con il registro interno esclusivamente nella colorazione nera.

Questo accessorio non solo permette una regolazione precisa della tensione della catena, ma integra un supporto pinza, offrendo un importante vantaggio: assicura il corretto posizionamento della pinza freno posteriore durante la regolazione e il cambio ruota, evitando movimenti indesiderati e semplificando le operazioni di manutenzione. Realizzato in resistente alluminio aeronautico e lavorato con macchinari CNC di alta precisione, questo tendicatena con supporto pinza garantisce robustezza e durata nel tempo, perfetto per chi cerca soluzioni di qualità professionale e migliorare l'esperienza di guida e manutenzione.

BRAND	MODEL - MODELLO	FROM - DAL	TO - AL	COLOUR - COLORE	CODE - CODICE	€	
Honda	CBR1000RR-R Fireblade	2020	2025	black - nero	CHAD10_BK	274,00	
Honda	CBR1000RR-R Fireblade	2020	2025	blue - blu	CHAD10_BL	274,00	
Honda	CBR1000RR-R Fireblade	2020	2025	gold - oro	CHAD10_GO	274,00	
Honda	CBR1000RR-R Fireblade	2020	2025	red - rosso	CHAD10_RE	274,00	
Honda	CBR1000RR-R Fireblade	2020	2025	silver - argento	CHAD10_SI	274,00	
Kawasaki	ZX-10R	2016	2025	black - nero	CHAD02_BK	274,00	
Kawasaki	ZX-10R	2016	2025	blue - blu	CHAD02_BL	274,00	
Kawasaki	ZX-10R	2016	2025	gold - oro	CHAD02_GO	274,00	
Kawasaki	ZX-10R	2016	2025	red - rosso	CHAD02_RE	274,00	
Kawasaki	ZX-10R	2016	2025	silver - argento	CHAD02_SI	274,00	
Kawasaki	ZX-6R	2024	2025	black - nero	CHAD16_BK	274,00	
Kawasaki	ZX-6R	2024	2025	blue - blu	CHAD16_BL	274,00	
Kawasaki	ZX-6R	2024	2025	gold - oro	CHAD16_GO	274,00	
Kawasaki	ZX-6R	2024	2025	red - rosso	CHAD16_RE	274,00	
Kawasaki	ZX-6R	2024	2025	silver - argento	CHAD16_SI	274,00	
Kawasaki	ZX-6R*	2024	2025	black - nero	CHAD16P_SI	323,00	
Suzuki	GSX-R 1000	2017	2025	black - nero	CHAD06_BK	274,00	
Suzuki	GSX-R 1000	2017	2025	blue - blu	CHAD06_BL	274,00	
Suzuki	GSX-R 1000	2017	2025	gold - oro	CHAD06_GO	274,00	
Suzuki	GSX-R 1000	2017	2025	red - rosso	CHAD06_RE	274,00	
Suzuki	GSX-R 1000	2017	2025	silver - argento	CHAD06_SI	274,00	
Suzuki	GSX-S 1000	2021	2025	black - nero	CHAD06_BK	274,00	
Suzuki	GSX-S 1000	2021	2025	blue - blu	CHAD06_BL	274,00	
Suzuki	GSX-S 1000	2021	2025	gold - oro	CHAD06_GO	274,00	
Suzuki	GSX-S 1000	2021	2025	red - rosso	CHAD06_RE	274,00	
Suzuki	GSX-S 1000	2021	2025	silver - argento	CHAD06_SI	274,00	
Yamaha	YZF R6	2017	2025	black - nero	CHAD07_BK	274,00	
Yamaha	YZF R6	2017	2025	blue - blu	CHAD07_BL	274,00	
Yamaha	YZF R6	2017	2025	gold - oro	CHAD07_GO	274,00	
Yamaha	YZF R6	2017	2025	red - rosso	CHAD07_RE	274,00	
Yamaha	YZF R6	2017	2025	silver - argento	CHAD07_SI	274,00	
Yamaha	YZF R6 *	2017	2025	black - nero	CHAD07P_BK	323,00	
Yamaha	YZF R1/MT-10	2015	2019	black - nero	CHAD03_BK	274,00	
Yamaha	YZF R1/MT-10	2015	2019	blue - blu	CHAD03_BL	274,00	
Yamaha	YZF R1/MT-10	2015	2019	gold - oro	CHAD03_GO	274,00	
Yamaha	YZF R1/MT-10	2015	2019	red - rosso	CHAD03_RE	274,00	
Yamaha	YZF R1/MT-10	2015	2019	silver - argento	CHAD03_SI	274,00	
Yamaha	YZF R1	2020	2025	black - nero	CHAD11_BK	274,00	
Yamaha	YZF R1	2020	2025	blue - blu	CHAD11_BL	274,00	
Yamaha	YZF R1	2020	2025	gold - oro	CHAD11_GO	274,00	
Yamaha	YZF R1	2020	2025	red - rosso	CHAD11_RE	274,00	
Yamaha	YZF R1	2020	2025	silver - argento	CHAD11_SI	274,00	
NEW	Yamaha	YZF R9	2025	2025	black - nero	CHAD17_BK	315,00
NEW	Yamaha	YZF R9	2025	2025	blue - blu	CHAD17_BL	315,00
NEW	Yamaha	YZF R9	2025	2025	gold - oro	CHAD17_GO	315,00
NEW	Yamaha	YZF R9	2025	2025	red - rosso	CHAD17_RE	315,00
NEW	Yamaha	YZF R9	2025	2025	silver - argento	CHAD17_SI	315,00
NEW	Yamaha	YZF R9 *	2025	2025	black - nero	CHAD17P_BK	372,00

* Chain adjuster with caliper support - Tendicatena con supporto pinza

Note on Colored Anodized Components - Nota sui componenti anodizzati colorati p.148



Honda CBR 600 RR
Code CHAD14_BL

PRICES WITHOUT VAT - PREZZI IVA ESCLUSA

FRONT FLUID RESERVOIR - SERBATOIO FLUIDO ANTERIORE



Includes three different fittings, is supplied with a rubber diaphragm, and comes with a three-piece bracket and a threaded lock ring.

Include tre tipi di raccordi, gommino in dotazione e staffa in tre parti con ghiera filettata.



DESCRIPTION - DESCRIZIONE

COLOUR- COLORE

CODE - CODICE

€

DESCRIPTION - DESCRIZIONE	COLOUR- COLORE	CODE - CODICE	€
30 ml Front fluid reservoir - Serbatoio fluido anteriore 30 ml	black - nero	VS40_BK	196,00
30 ml Front fluid reservoir - Serbatoio fluido anteriore 30 ml	blue - blu	VS40_BL	196,00
30 ml Front fluid reservoir - Serbatoio fluido anteriore 30 ml	bronze - bronzo	VS40_BR	196,00
30 ml Front fluid reservoir - Serbatoio fluido anteriore 30 ml	gold - oro	VS40_GO	196,00
30 ml Front fluid reservoir - Serbatoio fluido anteriore 30 ml	green - verde	VS40_GR	196,00
30 ml Front fluid reservoir - Serbatoio fluido anteriore 30 ml	orange - arancio	VS40_OR	196,00
30 ml Front fluid reservoir - Serbatoio fluido anteriore 30 ml	red - rosso	VS40_RE	196,00
30 ml Front fluid reservoir - Serbatoio fluido anteriore 30 ml	silver - argento	VS40_SI	196,00

Note on Colored Anodized Components - Nota sui componenti anodizzati colorati p.148

REAR BRAKE FLUID RESERVOIRS SPARE PARTS - RICAMBI SERBATOI FLUIDO FRENO POSTERIORE

DESCRIPTION - DESCRIZIONE

COLOUR - COLORE

CODE - CODICE

€

DESCRIPTION - DESCRIZIONE	COLOUR - COLORE	CODE - CODICE	€
Bracket tank - Supporto serbatoio	black	VS10S3	40,00

Made from high-strength aluminum, it is ideal for use in extreme conditions, resisting temperature variations and the chemical agents contained in the fluid.

Includes three different fittings - Supplied with rubber diaphragm - Comes with three-piece bracket and threaded lock ring.

Compatible with most sport, naked, and track motorcycles.

Realizzato in alluminio ad alta resistenza, è ideale per utilizzo in condizioni estreme; resiste a variazioni di temperatura e agenti chimici contenuti nel fluido freni.

Include: Tre tipi di raccordi inclusi - Gommino in dotazione - Staffa in tre parti con ghiera filettata.

Compatibili con la maggior parte delle moto sportive, naked e da pista.



REAR BRAKE FLUID RESERVOIRS - SERBATOI FLUIDO FRENO POSTERIORE



DESCRIPTION - DESCRIZIONE

COLOUR- COLORE

CODE - CODICE

€

10 ml Rear brake fluid reservoirs - Serbatoio fluido freno posteriore 10 ml	black - nero	VS10P_BK	120,00
10 ml Rear brake fluid reservoirs - Serbatoio fluido freno posteriore 10 ml	blue - blu	VS10P_BL	120,00
10 ml Rear brake fluid reservoirs - Serbatoio fluido freno posteriore 10 ml	bronze - bronzo	VS10P_BR	120,00
10 ml Rear brake fluid reservoirs - Serbatoio fluido freno posteriore 10 ml	gold - oro	VS10P_GO	120,00
10 ml Rear brake fluid reservoirs - Serbatoio fluido freno posteriore 10 ml	green - verde	VS10P_GR	120,00
10 ml Rear brake fluid reservoirs - Serbatoio fluido freno posteriore 10 ml	orange - arancio	VS10P_OR	120,00
10 ml Rear brake fluid reservoirs - Serbatoio fluido freno posteriore 10 ml	red - rosso	VS10P_RE	120,00
10 ml Rear brake fluid reservoirs - Serbatoio fluido freno posteriore 10 ml	silver - argento	VS10P_SI	120,00

Note on Colored Anodized Components - Nota sui componenti anodizzati colorati p.148



REAR BRAKE FLUID RESERVOIRS SPARE PARTS - RICAMBI SERBATOI FLUIDO FRENO POSTERIORE

DESCRIPTION - DESCRIZIONE

COLOUR- COLORE

CODE - CODICE

€

Bracket tank - Supporto serbatoio	black	VS10S3	40,00
-----------------------------------	-------	--------	-------

A new solution for the rear oil reservoir has been expressed by Bonamici Racing, always ready to undertake projects looking for style in step with time.

A new compact and captivating shape that does not penalize its maximum capacity, bringing it to 10ml for perfect autonomy during use.

The excellent chromatic effect was achieved by combining the black anodized cover with the contrasting body in various colours.

Like all Bonamici Racing products, the rear oil reservoir also uses an aluminum alloy for aeronautical use, made of billet aluminum with latest generation CNC machinery, treated with galvanic anodization in various colours.

Una nuova soluzione per la vaschetta olio posteriore è stato espresso da Bonamici Racing, sempre pronta ad intraprendere progetti alla ricerca di stili al passo col tempo.

Un nuova forma compatta ed accattivante che non ne penalizza la capacità massima portandola a 10ml per una perfetta autonomia durante l'utilizzo.

L'eccellente effetto cromatico è stato ottenuto mediante l'abbinamento del coperchio anodizzato nero con il corpo in contrasto in vari colori.

Come tutti i prodotti Bonamici Racing, anche per la vaschetta olio posteriore viene impiegata una lega di alluminio per uso aeronautico lavorata dal pieno con macchinari CNC di ultima generazione, trattata con anodizzazione galvanica in vari colori.

REAR BRAKE FLUID RESERVOIRS - SERBATOI FLUIDO FRENO POSTERIORE

Availability is limited; this product will be supplied while stocks last - Disponibilità limitata: il prodotto sarà fornito fino ad esaurimento scorte.



DESCRIPTION - DESCRIZIONE

COLOUR- COLORE

CODE - CODICE

€

8 ml Rear brake fluid reservoirs - Serbatoio fluido freno posteriore 8 ml	black - nero	0040_BK	60,00
8 ml Rear brake fluid reservoirs - Serbatoio fluido freno posteriore 8 ml	blue - blu	0040_BL	60,00
8 ml Rear brake fluid reservoirs - Serbatoio fluido freno posteriore 8 ml	bronze - bronzo	0040_BR	60,00
8 ml Rear brake fluid reservoirs - Serbatoio fluido freno posteriore 8 ml	gold - oro	0040_GO	60,00
8 ml Rear brake fluid reservoirs - Serbatoio fluido freno posteriore 8 ml	green - verde	0040_GR	60,00
8 ml Rear brake fluid reservoirs - Serbatoio fluido freno posteriore 8 ml	orange - arancio	0040_OR	60,00
8 ml Rear brake fluid reservoirs - Serbatoio fluido freno posteriore 8 ml	red - rosso	0040_RE	60,00
8 ml Rear brake fluid reservoirs - Serbatoio fluido freno posteriore 8 ml	silver - argento	0040_SI	60,00

Note on Colored Anodized Components - Nota sui componenti anodizzati colorati p.148

8 ml Rear brake fluid reservoir bracket - Supporto Serbato fluido freno posteriore 8 ml	black - nero	00S4	30,00
---	--------------	------	-------

PRICES WITHOUT VAT - PREZZI IVA ESCLUSA



The 8ml version has been redesigned with a more modern design. All reservoirs are made with aluminum machined from solid and are available in various colors.

La versione da 8ml è stata riprogettata con un design più moderno. I serbatoi sono in alluminio ricavati dal pieno e sono disponibili in vari colori.

EVO SWINGARMS SPOOLS - SUPPORTI CAVALLETTO EVO



STANDARD SWINGARMS SPOOLS
SUPPORTI CAVALLETTO STANDARD



RACING SWINGARMS SPOOLS
SUPPORTI CAVALLETTO RACING



black
nero



blue
blu



bronze
bronzo



gold
oro

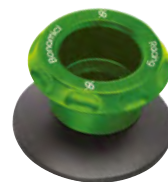

green
verde



orange
arancio



red
rosso



silver
argento

DESCRIPTION - DESCRIZIONE	COLOUR- COLORE	CODE - CODICE	€
standard ø 6 mm	black - nero	SCS6_BK	51,00
standard ø 6 mm	blue - blu	SCS6_BL	51,00
standard ø 6 mm	bronze - bronzo	SCS6_BR	51,00
standard ø 6 mm	gold - oro	SCS6_GO	51,00
standard ø 6 mm	green - verde	SCS6_GR	51,00
standard ø 6 mm	orange - arancio	SCS6_OR	51,00
standard ø 6 mm	red - rosso	SCS6_RE	51,00
standard ø 6 mm	silver - argento	SCS6_SI	51,00

DESCRIPTION - DESCRIZIONE	COLOUR- COLORE	CODE - CODICE	€
standard (connection - attacco M10 x 1,25)	black - nero	SCS10F_BK	51,00
standard (connection - attacco M10 x 1,25)	blue - blu	SCS10F_BL	51,00
standard (connection - attacco M10 x 1,25)	bronze - bronzo	SCS10F_BR	51,00
standard (connection - attacco M10 x 1,25)	gold - oro	SCS10F_GO	51,00
standard (connection - attacco M10 x 1,25)	green - verde	SCS10F_GR	51,00
standard (connection - attacco M10 x 1,25)	orange - arancio	SCS10F_OR	51,00
standard (connection - attacco M10 x 1,25)	red - rosso	SCS10F_RE	51,00
standard (connection - attacco M10 x 1,25)	silver - argento	SCS10F_SI	51,00

DESCRIPTION - DESCRIZIONE	COLOUR- COLORE	CODE - CODICE	€
standard ø 8 mm	black - nero	SCS8_BK	51,00
standard ø 8 mm	blue - blu	SCS8_BL	51,00
standard ø 8 mm	bronze - bronzo	SCS8_BR	51,00
standard ø 8 mm	gold - oro	SCS8_GO	51,00
standard ø 8 mm	green - verde	SCS8_GR	51,00
standard ø 8 mm	orange - arancio	SCS8_OR	51,00
standard ø 8 mm	red - rosso	SCS8_RE	51,00
standard ø 8 mm	silver - argento	SCS8_SI	51,00

DESCRIPTION - DESCRIZIONE	COLOUR- COLORE	CODE - CODICE	€
standard (connection - attacco M10 x 1,5)	black - nero	SCS10G_BK	51,00
standard (connection - attacco M10 x 1,5)	blue - blu	SCS10G_BL	51,00
standard (connection - attacco M10 x 1,5)	bronze - bronzo	SCS10G_BR	51,00
standard (connection - attacco M10 x 1,5)	gold - oro	SCS10G_GO	51,00
standard (connection - attacco M10 x 1,5)	green - verde	SCS10G_GR	51,00
standard (connection - attacco M10 x 1,5)	orange - arancio	SCS10G_OR	51,00
standard (connection - attacco M10 x 1,5)	red - rosso	SCS10G_RE	51,00
standard (connection - attacco M10 x 1,5)	silver - argento	SCS10G_SI	51,00

Note on Colored Anodized Components - Nota sui componenti anodizzati colorati p.148

Bonamici Racing, always careful to improve its products, introduces a new system for swingarm spools, with a modern and light design which, thanks to the combination of colored and black elements, results in a product with elegant, original, functional and strong aesthetic impacts.

This system is designed with modularity such as to cover all types of connections with M6, M8, M10x1.25 and M10x1.5 threads.

Completely machined from solid aluminum using the latest generation CNC machinery, the swingarm spools are available with anodization in various colors in both the standard version and the racing version.

Bonamici Racing, da sempre attenta a migliorare i propri prodotti, introduce un nuovo sistema per i supporti cavalletto, dal design moderno e leggero che, grazie all'abbinamento fra elementi colorati con elementi neri, dà come risultato un prodotto dal forte impatto stilistico e funzionale.

Questo sistema è concepito con una modularità tale da coprire tutte le tipologie di attacchi con filettature M6, M8, M10x1.25 ed M10x1.5.

Completamente in alluminio ricavati dal pieno con macchinari CNC di ultima generazione, i supporti cavalletto sono disponibili con anodizzazioni in vari colori sia nella versione standard che nella versione racing.

DESCRIPTION - DESCRIZIONE	COLOUR- COLORE	CODE - CODICE	€
racing ø 6 mm	black - nero	SCR6_BK	64,00
racing ø 6 mm	blue - blu	SCR6_BL	64,00
racing ø 6 mm	bronze - bronzo	SCR6_BR	64,00
racing ø 6 mm	gold - oro	SCR6_GO	64,00
racing ø 6 mm	green - verde	SCR6_GR	64,00
racing ø 6 mm	orange - arancio	SCR6_OR	64,00
racing ø 6 mm	red - rosso	SCR6_RE	64,00
racing ø 6 mm	silver - argento	SCR6_SI	64,00

DESCRIPTION - DESCRIZIONE	COLOUR- COLORE	CODE - CODICE	€
racing ø 8 mm	black - nero	SCR8_BK	64,00
racing ø 8 mm	blue - blu	SCR8_BL	64,00
racing ø 8 mm	bronze - bronzo	SCR8_BR	64,00
racing ø 8 mm	gold - oro	SCR8_GO	64,00
racing ø 8 mm	green - verde	SCR8_GR	64,00
racing ø 8 mm	orange - arancio	SCR8_OR	64,00
racing ø 8 mm	red - rosso	SCR8_RE	64,00
racing ø 8 mm	silver - argento	SCR8_SI	64,00

DESCRIPTION - DESCRIZIONE	COLOUR- COLORE	CODE - CODICE	€
racing (connection - attacco M10 x 1,25)	black - nero	SCR10F_BK	64,00
racing (connection - attacco M10 x 1,25)	blue - blu	SCR10F_BL	64,00
racing (connection - attacco M10 x 1,25)	bronze - bronzo	SCR10F_BR	64,00
racing (connection - attacco M10 x 1,25)	gold - oro	SCR10F_GO	64,00
racing (connection - attacco M10 x 1,25)	green - verde	SCR10F_GR	64,00
racing (connection - attacco M10 x 1,25)	orange - arancio	SCR10F_OR	64,00
racing (connection - attacco M10 x 1,25)	red - rosso	SCR10F_RE	64,00
racing (connection - attacco M10 x 1,25)	silver - argento	SCR10F_SI	64,00

DESCRIPTION - DESCRIZIONE	COLOUR- COLORE	CODE - CODICE	€
racing (connection - attacco M10 x 1,5)	black - nero	SCR10G_BK	64,00
racing (connection - attacco M10 x 1,5)	blue - blu	SCR10G_BL	64,00
racing (connection - attacco M10 x 1,5)	bronze - bronzo	SCR10G_BR	64,00
racing (connection - attacco M10 x 1,5)	gold - oro	SCR10G_GO	64,00
racing (connection - attacco M10 x 1,5)	green - verde	SCR10G_GR	64,00
racing (connection - attacco M10 x 1,5)	orange - arancio	SCR10G_OR	64,00
racing (connection - attacco M10 x 1,5)	red - rosso	SCR10G_RE	64,00
racing (connection - attacco M10 x 1,5)	silver - argento	SCR10G_SI	64,00

Note on Colored Anodized Components - Nota sui componenti anodizzati colorati p.148



SWINGARMS SPOOLS - SUPPORTI CAVALLETTO



DESCRIPTION - DESCRIZIONE	COLOUR- COLORE	CODE - CODICE	€
classic ø 6 mm	black - nero	0025_BK	38,00
classic ø 6 mm	blue - blu	0025_BL	38,00
classic ø 6 mm	bronze - bronzo	0025_BR	38,00
classic ø 6 mm	gold - oro	0025_GO	38,00
classic ø 6 mm	green - verde	0025_GR	38,00
classic ø 6 mm	orange - arancio	0025_OR	38,00
classic ø 6 mm	red - rosso	0025_RE	38,00
classic ø 6 mm	silver - argento	0025_SI	38,00
classic ø 8 mm	black - nero	0026_BK	38,00
classic ø 8 mm	blue - blu	0026_BL	38,00
classic ø 8 mm	bronze - bronzo	0026_BR	38,00
classic ø 8 mm	gold - oro	0026_GO	38,00
classic ø 8 mm	green - verde	0026_GR	38,00
classic ø 8 mm	orange - arancio	0026_OR	38,00
classic ø 8 mm	red - rosso	0026_RE	38,00
classic ø 8 mm	silver - argento	0026_SI	38,00
classic "racing" ø 6 mm	black - nero	0027_BK	43,00
classic "racing" ø 8 mm	black - nero	0028_BK	43,00

Note on Colored Anodized Components - Nota sui componenti anodizzati colorati p.148



The rear stand supports, made in aluminum machined from solid, are available in the following sizes, 6mm, 8mm, are available in various colors.

I supporti posteriori per i cavalletti in alluminio ricavati dal pieno sono disponibili nelle misure da 6mm, da 8mm e vari colori.



BLOCKS MIRROR - TAPPI SPECCHIO



PRICES WITHOUT VAT - PREZZI IVA ESCLUSA



BRAND	MODEL - MODELLO	COLOUR- COLORE	CODE - CODICE	€
BMW	S 1000 RR (2019/2025)	black - nero	BM07_BK	69,00
BMW	S 1000 RR (2019/2025)	blue - blu	BM07_BL	69,00
BMW	S 1000 RR (2019/2025)	gold - oro	BM07_GO	69,00
BMW	S 1000 RR (2019/2025)	orange - arancio	BM07_OR	69,00
BMW	S 1000 RR (2019/2025)	red - rosso	BM07_RE	69,00
BMW	S 1000 RR (2019/2025)	silver - argento	BM07_SI	69,00
Ducati	Panigale V2 (2020-2024) / Panigale V4 (2018-2024)	black - nero	BM06_BK	69,00
Ducati	Panigale V2 (2020-2024) / Panigale V4 (2018-2024)	blue - blu	BM06_BL	69,00
Ducati	Panigale V2 (2020-2024) / Panigale V4 (2018-2024)	gold - oro	BM06_GO	69,00
Ducati	Panigale V2 (2020-2024) / Panigale V4 (2018-2024)	orange - arancio	BM06_OR	69,00
Ducati	Panigale V2 (2020-2024) / Panigale V4 (2018-2024)	red - rosso	BM06_RE	69,00
Ducati	Panigale V2 (2020-2024) / Panigale V4 (2018-2024)	silver - argento	BM06_SI	69,00
Yamaha	YZF R7 (2021-2025) - YZF R9 (2025-2025)	black - nero	BM08_BK	69,00
Yamaha	YZF R7 (2021-2025) - YZF R9 (2025-2025)	blue - blu	BM08_BL	69,00
Yamaha	YZF R7 (2021-2025) - YZF R9 (2025-2025)	gold - oro	BM08_GO	69,00
Yamaha	YZF R7 (2021-2025) - YZF R9 (2025-2025)	orange - arancio	BM08_OR	69,00
Yamaha	YZF R7 (2021-2025) - YZF R9 (2025-2025)	red - rosso	BM08_RE	69,00
Yamaha	YZF R7 (2021-2025) - YZF R9 (2025-2025)	silver - argento	BM08_SI	69,00

Note on Colored Anodized Components - Nota sui componenti anodizzati colorati p.148



YAMAHA YZF R9 (2025)
code BM08_BK



OIL CAPS - TAPPI OLIO



Note on Colored Anodized Components - Nota sui componenti anodizzati colorati p.148



BRAND	MODEL - MODELLO	THREAD - FILETTO	COLOUR- COLORE	CODE - CODICE	€
Aprilia	Tuareg 660	M18x1,5	black - nero	T010_BK	39,00
Aprilia	Tuareg 660	M18x1,5	blue - blu	T010_BL	39,00
Aprilia	Tuareg 660	M18x1,5	gold - oro	T010_GO	39,00
Aprilia	Tuareg 660	M18x1,5	green - verde	T010_GR	39,00
Aprilia	Tuareg 660	M18x1,5	orange - arancio	T010_OR	39,00
Aprilia	Tuareg 660	M18x1,5	red - rosso	T010_RE	39,00
Aprilia	Tuareg 660	M18x1,5	silver - argento	T010_SI	39,00

Aprilia	RS 660	M20x1,5	black - nero	T011_BK	39,00
Aprilia	RS 660	M20x1,5	blue - blu	T011_BL	39,00
Aprilia	RS 660	M20x1,5	gold - oro	T011_GO	39,00
Aprilia	RS 660	M20x1,5	green - verde	T011_GR	39,00
Aprilia	RS 660	M20x1,5	orange - arancio	T011_OR	39,00
Aprilia	RS 660	M20x1,5	red - rosso	T011_RE	39,00
Aprilia	RS 660	M20x1,5	silver - argento	T011_SI	39,00

BMW	universal	M24x2	black - nero	T004_BK	39,00
BMW	universal	M24x2	blue - blu	T004_BL	39,00
BMW	universal	M24x2	gold - oro	T004_GO	39,00
BMW	universal	M24x2	green - verde	T004_GR	39,00
BMW	universal	M24x2	orange - arancio	T004_OR	39,00
BMW	universal	M24x2	red - rosso	T004_RE	39,00
BMW	universal	M24x2	silver - argento	T004_SI	39,00

BRAND	MODEL - MODELLO	THREAD - FILETTO	COLOUR- COLORE	CODE - CODICE	€
Ducati	Panigale V2 - Streetfighter V2 (for models up to 2024) Multistrada V4 - Panigale 899/1199	M19,5x2,5	black - nero	T003_BK	39,00
Ducati	Panigale V2 - Streetfighter V2 (for models up to 2024) Multistrada V4 - Panigale 899/1199	M19,5x2,5	blue - blu	T003_BL	39,00
Ducati	Panigale V2 - Streetfighter V2 (for models up to 2024) Multistrada V4 - Panigale 899/1199	M19,5x2,5	gold - oro	T003_GO	39,00
Ducati	Panigale V2 - Streetfighter V2 (for models up to 2024) Multistrada V4 - Panigale 899/1199	M19,5x2,5	green - verde	T003_GR	39,00
Ducati	Panigale V2 - Streetfighter V2 (for models up to 2024) Multistrada V4 - Panigale 899/1199	M19,5x2,5	orange - arancio	T003_OR	39,00
Ducati	Panigale V2 - Streetfighter V2 (for models up to 2024) Multistrada V4 - Panigale 899/1199	M19,5x2,5	red - rosso	T003_RE	39,00
Ducati	Panigale V2 - Streetfighter V2 (for models up to 2024) Multistrada V4 - Panigale 899/1199	M19,5x2,5	silver - argento	T003_SI	39,00

Ducati	Panigale V4 - Streetfighter V4 - Panigale 1299 - Streetfighter 848 Monster 821/937/1100/1200 - Hypermotard 821/939/950 - 848	M20x2,5	black - nero	T008_BK	39,00
Ducati	Panigale V4 - Streetfighter V4 - Panigale 1299 - Streetfighter 848 Monster 821/937/1100/1200 - Hypermotard 821/939/950 - 848	M20x2,5	blue - blu	T008_BL	39,00
Ducati	Panigale V4 - Streetfighter V4 - Panigale 1299 - Streetfighter 848 Monster 821/937/1100/1200 - Hypermotard 821/939/950 - 848	M20x2,5	gold - oro	T008_GO	39,00
Ducati	Panigale V4 - Streetfighter V4 - Panigale 1299 - Streetfighter 848 Monster 821/937/1100/1200 - Hypermotard 821/939/950 - 848	M20x2,5	green - verde	T008_GR	39,00
Ducati	Panigale V4 - Streetfighter V4 - Panigale 1299 - Streetfighter 848 Monster 821/937/1100/1200 - Hypermotard 821/939/950 - 848	M20x2,5	orange - arancio	T008_OR	39,00
Ducati	Panigale V4 - Streetfighter V4 - Panigale 1299 - Streetfighter 848 Monster 821/937/1100/1200 - Hypermotard 821/939/950 - 848	M20x2,5	red - rosso	T008_RE	39,00
Ducati	Panigale V4 - Streetfighter V4 - Panigale 1299 - Streetfighter 848 Monster 821/937/1100/1200 - Hypermotard 821/939/950 - 848	M20x2,5	silver - argento	T008_SI	39,00

BRAND	MODEL - MODELLO	THREAD - FILETTO	COLOUR- COLORE	CODE - CODICE	€
Ducati	universal	M22x1,5	black - nero	T001_BK	39,00
Ducati	universal	M22x1,5	blue - blu	T001_BL	39,00
Ducati	universal	M22x1,5	gold - oro	T001_GO	39,00
Ducati	universal	M22x1,5	green - verde	T001_GR	39,00
Ducati	universal	M22x1,5	orange - arancio	T001_OR	39,00
Ducati	universal	M22x1,5	red - rosso	T001_RE	39,00
Ducati	universal	M22x1,5	silver - argento	T001_SI	39,00
Honda	universal	M19,5 x 2,5	black - nero	T003_BK	39,00
Honda	universal	M19,5 x 2,5	blue - blu	T003_BL	39,00
Honda	universal	M19,5 x 2,5	gold - oro	T003_GO	39,00
Honda	universal	M19,5 x 2,5	green - verde	T003_GR	39,00
Honda	universal	M19,5 x 2,5	orange - arancio	T003_OR	39,00
Honda	universal	M19,5 x 2,5	red - rosso	T003_RE	39,00
Honda	universal	M19,5 x 2,5	silver - argento	T003_SI	39,00
Kawasaki	universal	M30x1,5	black - nero	T002_BK	39,00
Kawasaki	universal	M30x1,5	blue - blu	T002_BL	39,00
Kawasaki	universal	M30x1,5	gold - oro	T002_GO	39,00
Kawasaki	universal	M30x1,5	green - verde	T002_GR	39,00
Kawasaki	universal	M30x1,5	orange - arancio	T002_OR	39,00
Kawasaki	universal	M30x1,5	red - rosso	T002_RE	39,00
Kawasaki	universal	M30x1,5	silver - argento	T002_SI	39,00
Kawasaki	Ninja 250/400 - Z650 - Z800/900 - Z1000 (14/15) ZX-4R/RR (23-2025)	M20x2,5	black - nero	T008_BK	39,00
Kawasaki	Ninja 250/400 - Z650 - Z800/900 - Z1000 (14/15) ZX-4R/RR (23-2025)	M20x2,5	blue - blu	T008_BL	39,00
Kawasaki	Ninja 250/400 - Z650 - Z800/900 - Z1000 (14/15) ZX-4R/RR (23-2025)	M20x2,5	gold - oro	T008_GO	39,00
Kawasaki	Ninja 250/400 - Z650 - Z800/900 - Z1000 (14/15) ZX-4R/RR (23-2025)	M20x2,5	green - verde	T008_GR	39,00
Kawasaki	Ninja 250/400 - Z650 - Z800/900 - Z1000 (14/15) ZX-4R/RR (23-2025)	M20x2,5	orange - arancio	T008_OR	39,00
Kawasaki	Ninja 250/400 - Z650 - Z800/900 - Z1000 (14/15) ZX-4R/RR (23-2025)	M20x2,5	red - rosso	T008_RE	39,00
Kawasaki	Ninja 250/400 - Z650 - Z800/900 - Z1000 (14/15) ZX-4R/RR (23-2025)	M20x2,5	silver - argento	T008_SI	39,00
Suzuki	universal	M20x1,5	black - nero	T005_BK	39,00
Suzuki	universal	M20x1,5	blue - blu	T005_BL	39,00
Suzuki	universal	M20x1,5	gold - oro	T005_GO	39,00
Suzuki	universal	M20x1,5	green - verde	T005_GR	39,00
Suzuki	universal	M20x1,5	orange - arancio	T005_OR	39,00
Suzuki	universal	M20x1,5	red - rosso	T005_RE	39,00
Suzuki	universal	M20x1,5	silver - argento	T005_SI	39,00

BRAND	MODEL - MODELLO	THREAD - FILETTO	COLOUR- COLORE	CODE - CODICE	€
Triumph	universal	M19,5x2,5	black - nero	T003_BK	39,00
Triumph	universal	M19,5x2,5	blue - blu	T003_BL	39,00
Triumph	universal	M19,5x2,5	gold - oro	T003_GO	39,00
Triumph	universal	M19,5x2,5	green - verde	T003_GR	39,00
Triumph	universal	M19,5x2,5	orange - arancio	T003_OR	39,00
Triumph	universal	M19,5x2,5	red - rosso	T003_RE	39,00
Triumph	universal	M19,5x2,5	silver - argento	T003_SI	39,00
Triumph	Street Triple 765 - Speed Triple 1200 RS/RR	M20x2,5	black - nero	T009_BK	39,00
Triumph	Street Triple 765 - Speed Triple 1200 RS/RR	M20x2,5	blue - blu	T009_BL	39,00
Triumph	Street Triple 765 - Speed Triple 1200 RS/RR	M20x2,5	gold - oro	T009_GO	39,00
Triumph	Street Triple 765 - Speed Triple 1200 RS/RR	M20x2,5	green - verde	T009_GR	39,00
Triumph	Street Triple 765 - Speed Triple 1200 RS/RR	M20x2,5	orange - arancio	T009_OR	39,00
Triumph	Street Triple 765 - Speed Triple 1200 RS/RR	M20x2,5	red - rosso	T009_RE	39,00
Triumph	Street Triple 765 - Speed Triple 1200 RS/RR	M20x2,5	silver - argento	T009_SI	39,00
Yamaha	universal	M27x3	black - nero	T007_BK	39,00
Yamaha	universal	M27x3	blue - blu	T007_BL	39,00
Yamaha	universal	M27x3	gold - oro	T007_GO	39,00
Yamaha	universal	M27x3	green - verde	T007_GR	39,00
Yamaha	universal	M27x3	orange - arancio	T007_OR	39,00
Yamaha	universal	M27x3	red - rosso	T007_RE	39,00
Yamaha	universal	M27x3	silver - argento	T007_SI	39,00
Yamaha	MT-03	M19,5x2,5	black - nero	T003_BK	39,00
Yamaha	MT-03	M19,5x2,5	blue - blu	T003_BL	39,00
Yamaha	MT-03	M19,5x2,5	gold - oro	T003_GO	39,00
Yamaha	MT-03	M19,5x2,5	green - verde	T003_GR	39,00
Yamaha	MT-03	M19,5x2,5	orange - arancio	T003_OR	39,00
Yamaha	MT-03	M19,5x2,5	red - rosso	T003_RE	39,00
Yamaha	MT-03	M19,5x2,5	silver - argento	T003_SI	39,00
Yamaha	MT-09 (2013-2025)	M20x2,5	black - nero	T008_BK	39,00
Yamaha	MT-09 (2013-2025)	M20x2,5	blue - blu	T008_BL	39,00
Yamaha	MT-09 (2013-2025)	M20x2,5	gold - oro	T008_GO	39,00
Yamaha	MT-09 (2013-2025)	M20x2,5	green - verde	T008_GR	39,00
Yamaha	MT-09 (2013-2025)	M20x2,5	orange - arancio	T008_OR	39,00
Yamaha	MT-09 (2013-2025)	M20x2,5	red - rosso	T008_RE	39,00
Yamaha	MT-09 (2013-2025)	M20x2,5	silver - argento	T008_SI	39,00
Yamaha	YZF R9 (2025-2025)	M20x2,5	black - nero	T009_BK	39,00
Yamaha	YZF R9 (2025-2025)	M20x2,5	blue - blu	T009_BL	39,00
Yamaha	YZF R9 (2025-2025)	M20x2,5	gold - oro	T009_GO	39,00
Yamaha	YZF R9 (2025-2025)	M20x2,5	green - verde	T009_GR	39,00
Yamaha	YZF R9 (2025-2025)	M20x2,5	orange - arancio	T009_OR	39,00
Yamaha	YZF R9 (2025-2025)	M20x2,5	red - rosso	T009_RE	39,00
Yamaha	YZF R9 (2025-2025)	M20x2,5	silver - argento	T009_SI	39,00

TANK CAPS - TAPPI SERBATOIO



Note on Colored Anodized Components - Nota sui componenti anodizzati colorati p.148



blue
blu

bronze
bronzo

gold
oro

green
verde

orange
arancio

red
rosso

silver
argento

SPARE PART - RICAMBI

DESCRIPTION - DESCRIZIONE	COLOUR- COLORE	CODE - CODICE	€
Center cap - Tappo centrale	black - nero	FC00C_BK	61,00
Center cap - Tappo centrale	blue - blu	FC00C_BL	86,00
Center cap - Tappo centrale	bronze - bronzo	FC00C_BR	86,00
Center cap - Tappo centrale	gold - oro	FC00C_GO	86,00
Center cap - Tappo centrale	green - verde	FC00C_GR	86,00
Center cap - Tappo centrale	orange - arancio	FC00C_OR	86,00
Center cap - Tappo centrale	red - rosso	FC00C_RE	86,00
Center cap - Tappo centrale	silver - argento	FC00C_SI	86,00

BRAND	MODEL - MODELLO	FROM - DAL	TO - AL	COLOUR- COLORE	CODE - CODICE	€
APRILIA	RS 660 / TUONO 660	2020	2025	black - nero	FC090_BK	118,00
APRILIA	RS 660 / TUONO 660	2020	2025	blue - blu	FC090_BL	145,00
APRILIA	RS 660 / TUONO 660	2020	2025	bronze - bronzo	FC090_BR	145,00
APRILIA	RS 660 / TUONO 660	2020	2025	gold - oro	FC090_GO	145,00
APRILIA	RS 660 / TUONO 660	2020	2025	green - verde	FC090_GR	145,00
APRILIA	RS 660 / TUONO 660	2020	2025	orange - arancio	FC090_OR	145,00
APRILIA	RS 660 / TUONO 660	2020	2025	red - rosso	FC090_RE	145,00
APRILIA	RS 660 / TUONO 660	2020	2025	silver - argento	FC090_SI	145,00

APRILIA	RSV 1000 / RSV4 / TUONO / RSV4 Factory	2004	2024	black - nero	FC030_BK	118,00
APRILIA	RSV 1000 / RSV4 / TUONO / RSV4 Factory	2004	2024	blue - blu	FC030_BL	145,00
APRILIA	RSV 1000 / RSV4 / TUONO / RSV4 Factory	2004	2024	bronze - bronzo	FC030_BR	145,00
APRILIA	RSV 1000 / RSV4 / TUONO / RSV4 Factory	2004	2024	gold - oro	FC030_GO	145,00
APRILIA	RSV 1000 / RSV4 / TUONO / RSV4 Factory	2004	2024	green - verde	FC030_GR	145,00
APRILIA	RSV 1000 / RSV4 / TUONO / RSV4 Factory	2004	2024	orange - arancio	FC030_OR	145,00
APRILIA	RSV 1000 / RSV4 / TUONO / RSV4 Factory	2004	2024	red - rosso	FC030_RE	145,00
APRILIA	RSV 1000 / RSV4 / TUONO / RSV4 Factory	2004	2024	silver - argento	FC030_SI	145,00

TANK CAPS - TAPPI SERBATOIO

BRAND	MODEL - MODELLO	FROM - DAL	TO - AL	COLOUR- COLORE	CODE - CODICE	€
BMW	S 1000 R - M 1000 R - S 1000 RR - M 1000RR - HP4	2008	2025	black - nero	FC040_BK	118,00
BMW	S 1000 R - M 1000 R - S 1000 RR - M 1000RR - HP4	2008	2025	blue - blu	FC040_BL	145,00
BMW	S 1000 R - M 1000 R - S 1000 RR - M 1000RR - HP4	2008	2025	bronze - bronzo	FC040_BR	145,00
BMW	S 1000 R - M 1000 R - S 1000 RR - M 1000RR - HP4	2008	2025	gold - oro	FC040_GO	145,00
BMW	S 1000 R - M 1000 R - S 1000 RR - M 1000RR - HP4	2008	2025	green - verde	FC040_GR	145,00
BMW	S 1000 R - M 1000 R - S 1000 RR - M 1000RR - HP4	2008	2025	orange - arancio	FC040_OR	145,00
BMW	S 1000 R - M 1000 R - S 1000 RR - M 1000RR - HP4	2008	2025	red - rosso	FC040_RE	145,00
BMW	S 1000 R - M 1000 R - S 1000 RR - M 1000RR - HP4	2008	2025	silver - argento	FC040_SI	145,00

DUCATI	748 / 916 / 996 / 998 / 848 / 1098	-	-	black - nero	FC010_BK	118,00
DUCATI	748 / 916 / 996 / 998 / 848 / 1098	-	-	blue - blu	FC010_BL	145,00
DUCATI	748 / 916 / 996 / 998 / 848 / 1098	-	-	bronze - bronzo	FC010_BR	145,00
DUCATI	748 / 916 / 996 / 998 / 848 / 1098	-	-	gold - oro	FC010_GO	145,00
DUCATI	748 / 916 / 996 / 998 / 848 / 1098	-	-	green - verde	FC010_GR	145,00
DUCATI	748 / 916 / 996 / 998 / 848 / 1098	-	-	orange - arancio	FC010_OR	145,00
DUCATI	748 / 916 / 996 / 998 / 848 / 1098	-	-	red - rosso	FC010_RE	145,00
DUCATI	748 / 916 / 996 / 998 / 848 / 1098	-	-	silver - argento	FC010_SI	145,00

DUCATI	Panigale 899 / 1199 / 1299 / V2/ V4/ V4S/ V4R	2012	2025	black - nero	FC050_BK	118,00
DUCATI	Panigale 899 / 1199 / 1299 / V2/ V4/ V4S/ V4R	2012	2025	blue - blu	FC050_BL	145,00
DUCATI	Panigale 899 / 1199 / 1299 / V2/ V4/ V4S/ V4R	2012	2025	bronze - bronzo	FC050_BR	145,00
DUCATI	Panigale 899 / 1199 / 1299 / V2/ V4/ V4S/ V4R	2012	2025	gold - oro	FC050_GO	145,00
DUCATI	Panigale 899 / 1199 / 1299 / V2/ V4/ V4S/ V4R	2012	2025	green - verde	FC050_GR	145,00
DUCATI	Panigale 899 / 1199 / 1299 / V2/ V4/ V4S/ V4R	2012	2025	orange - arancio	FC050_OR	145,00
DUCATI	Panigale 899 / 1199 / 1299 / V2/ V4/ V4S/ V4R	2012	2025	red - rosso	FC050_RE	145,00
DUCATI	Panigale 899 / 1199 / 1299 / V2/ V4/ V4S/ V4R	2012	2025	silver - argento	FC050_SI	145,00

DUCATI	Streetfighter / Scrambler 800	2009	2025	black - nero	FC050_BK	118,00
DUCATI	Streetfighter / Scrambler 800	2009	2025	blue - blu	FC050_BL	145,00
DUCATI	Streetfighter / Scrambler 800	2009	2025	bronze - bronzo	FC050_BR	145,00
DUCATI	Streetfighter / Scrambler 800	2009	2025	gold - oro	FC050_GO	145,00
DUCATI	Streetfighter / Scrambler 800	2009	2025	green - verde	FC050_GR	145,00
DUCATI	Streetfighter / Scrambler 800	2009	2025	orange - arancio	FC050_OR	145,00
DUCATI	Streetfighter / Scrambler 800	2009	2025	red - rosso	FC050_RE	145,00
DUCATI	Streetfighter / Scrambler 800	2009	2025	silver - argento	FC050_SI	145,00

HONDA	CBR 500 R - CBR 650 R/F	2012	2023	black - nero	FC120_BK	118,00
HONDA	CBR 500 R - CBR 650 R/F	2012	2023	blue - blu	FC120_BL	145,00
HONDA	CBR 500 R - CBR 650 R/F	2012	2023	bronze - bronzo	FC120_BR	145,00
HONDA	CBR 500 R - CBR 650 R/F	2012	2023	gold - oro	FC120_GO	145,00
HONDA	CBR 500 R - CBR 650 R/F	2012	2023	green - verde	FC120_GR	145,00
HONDA	CBR 500 R - CBR 650 R/F	2012	2023	orange - arancio	FC120_OR	145,00
HONDA	CBR 500 R - CBR 650 R/F	2012	2023	red - rosso	FC120_RE	145,00
HONDA	CBR 500 R - CBR 650 R/F	2012	2023	silver - argento	FC120_SI	145,00

BRAND	MODEL - MODELLO	FROM - DAL	TO - AL	COLOUR- COLORE	CODE - CODICE	€
HONDA	CBR 600 RR	2003	2025	black - nero	FC160_BK	118,00
HONDA	CBR 600 RR	2003	2025	blue - blu	FC160_BL	145,00
HONDA	CBR 600 RR	2003	2025	bronze - bronzo	FC160_BR	145,00
HONDA	CBR 600 RR	2003	2025	gold - oro	FC160_GO	145,00
HONDA	CBR 600 RR	2003	2025	green - verde	FC160_GR	145,00
HONDA	CBR 600 RR	2003	2025	orange - arancio	FC160_OR	145,00
HONDA	CBR 600 RR	2003	2025	red - rosso	FC160_RE	145,00
HONDA	CBR 600 RR	2003	2025	silver - argento	FC160_SI	145,00

HONDA	CBR 1000 RR	2004	2013	black - nero	FC160_BK	118,00
HONDA	CBR 1000 RR	2004	2013	blue - blu	FC160_BL	145,00
HONDA	CBR 1000 RR	2004	2013	bronze - bronzo	FC160_BR	145,00
HONDA	CBR 1000 RR	2004	2013	gold - oro	FC160_GO	145,00
HONDA	CBR 1000 RR	2004	2013	green - verde	FC160_GR	145,00
HONDA	CBR 1000 RR	2004	2013	orange - arancio	FC160_OR	145,00
HONDA	CBR 1000 RR	2004	2013	red - rosso	FC160_RE	145,00
HONDA	CBR 1000 RR	2004	2013	silver - argento	FC160_SI	145,00

HONDA	CBR 1000 RR	2014	2016	black - nero	FC150_BK	118,00
HONDA	CBR 1000 RR	2014	2016	blue - blu	FC150_BL	145,00
HONDA	CBR 1000 RR	2014	2016	bronze - bronzo	FC150_BR	145,00
HONDA	CBR 1000 RR	2014	2016	gold - oro	FC150_GO	145,00
HONDA	CBR 1000 RR	2014	2016	green - verde	FC150_GR	145,00
HONDA	CBR 1000 RR	2014	2016	orange - arancio	FC150_OR	145,00
HONDA	CBR 1000 RR	2014	2016	red - rosso	FC150_RE	145,00
HONDA	CBR 1000 RR	2014	2016	silver - argento	FC150_SI	145,00

HONDA	CBR 1000 RR Fireblade/RR-R	2017	2025	black - nero	FC120_BK	118,00
HONDA	CBR 1000 RR Fireblade/RR-R	2017	2025	blue - blu	FC120_BL	145,00
HONDA	CBR 1000 RR Fireblade/RR-R	2017	2025	bronze - bronzo	FC120_BR	145,00
HONDA	CBR 1000 RR Fireblade/RR-R	2017	2025	gold - oro	FC120_GO	145,00
HONDA	CBR 1000 RR Fireblade/RR-R	2017	2025	green - verde	FC120_GR	145,00
HONDA	CBR 1000 RR Fireblade/RR-R	2017	2025	orange - arancio	FC120_OR	145,00
HONDA	CBR 1000 RR Fireblade/RR-R	2017	2025	red - rosso	FC120_RE	145,00
HONDA	CBR 1000 RR Fireblade/RR-R	2017	2025	silver - argento	FC120_SI	145,00

KAWASAKI	Ninja 250/400 (2018/2023) - ZX-4R/RR (2023/2025)			black - nero	FC170_BK	118,00
KAWASAKI	Ninja 250/400 (2018/2023) - ZX-4R/RR (2023/2025)			blue - blu	FC170_BL	145,00
KAWASAKI	Ninja 250/400 (2018/2023) - ZX-4R/RR (2023/2025)			bronze - bronzo	FC170_BR	145,00
KAWASAKI	Ninja 250/400 (2018/2023) - ZX-4R/RR (2023/2025)			gold - oro	FC170_GO	145,00
KAWASAKI	Ninja 250/400 (2018/2023) - ZX-4R/RR (2023/2025)			green - verde	FC170_GR	145,00
KAWASAKI	Ninja 250/400 (2018/2023) - ZX-4R/RR (2023/2025)			orange - arancio	FC170_OR	145,00
KAWASAKI	Ninja 250/400 (2018/2023) - ZX-4R/RR (2023/2025)			red - rosso	FC170_RE	145,00
KAWASAKI	Ninja 250/400 (2018/2023) - ZX-4R/RR (2023/2025)			silver - argento	FC170_SI	145,00

TANK CAPS - TAPPI SERBATOIO

BRAND	MODEL - MODELLO	FROM - DAL	TO - AL	COLOUR- COLORE	CODE - CODICE	€
KAWASAKI	ZX-6R	2007	2017	black - nero	FC070_BK	118,00
KAWASAKI	ZX-6R	2007	2017	blue - blu	FC070_BL	145,00
KAWASAKI	ZX-6R	2007	2017	bronze - bronzo	FC070_BR	145,00
KAWASAKI	ZX-6R	2007	2017	gold - oro	FC070_GO	145,00
KAWASAKI	ZX-6R	2007	2017	green - verde	FC070_GR	145,00
KAWASAKI	ZX-6R	2007	2017	orange - arancio	FC070_OR	145,00
KAWASAKI	ZX-6R	2007	2017	red - rosso	FC070_RE	145,00
KAWASAKI	ZX-6R	2007	2017	silver - argento	FC070_SI	145,00

KAWASAKI	ZX-6R	2018	2025	black - nero	FC170_BK	118,00
KAWASAKI	ZX-6R	2018	2025	blue - blu	FC170_BL	145,00
KAWASAKI	ZX-6R	2018	2025	bronze - bronzo	FC170_BR	145,00
KAWASAKI	ZX-6R	2018	2025	gold - oro	FC170_GO	145,00
KAWASAKI	ZX-6R	2018	2025	green - verde	FC170_GR	145,00
KAWASAKI	ZX-6R	2018	2025	orange - arancio	FC170_OR	145,00
KAWASAKI	ZX-6R	2018	2025	red - rosso	FC170_RE	145,00
KAWASAKI	ZX-6R	2018	2025	silver - argento	FC170_SI	145,00

KAWASAKI	ZX-10R	2006	2020	black - nero	FC070_BK	118,00
KAWASAKI	ZX-10R	2006	2020	blue - blu	FC070_BL	145,00
KAWASAKI	ZX-10R	2006	2020	bronze - bronzo	FC070_BR	145,00
KAWASAKI	ZX-10R	2006	2020	gold - oro	FC070_GO	145,00
KAWASAKI	ZX-10R	2006	2020	green - verde	FC070_GR	145,00
KAWASAKI	ZX-10R	2006	2020	orange - arancio	FC070_OR	145,00
KAWASAKI	ZX-10R	2006	2020	red - rosso	FC070_RE	145,00
KAWASAKI	ZX-10R	2006	2020	silver - argento	FC070_SI	145,00

KAWASAKI	ZX-10R	2021	2025	black - nero	FC170_BK	118,00
KAWASAKI	ZX-10R	2021	2025	blue - blu	FC170_BL	145,00
KAWASAKI	ZX-10R	2021	2025	bronze - bronzo	FC170_BR	145,00
KAWASAKI	ZX-10R	2021	2025	gold - oro	FC170_GO	145,00
KAWASAKI	ZX-10R	2021	2025	green - verde	FC170_GR	145,00
KAWASAKI	ZX-10R	2021	2025	orange - arancio	FC170_OR	145,00
KAWASAKI	ZX-10R	2021	2025	red - rosso	FC170_RE	145,00
KAWASAKI	ZX-10R	2021	2025	silver - argento	FC170_SI	145,00

KAWASAKI	ER-6N/Z 800/Z 1000	2007	2016	black - nero	FC070_BK	118,00
KAWASAKI	ER-6N/Z 800/Z 1000	2007	2016	blue - blu	FC070_BL	145,00
KAWASAKI	ER-6N/Z 800/Z 1000	2007	2016	bronze - bronzo	FC070_BR	145,00
KAWASAKI	ER-6N/Z 800/Z 1000	2007	2016	gold - oro	FC070_GO	145,00
KAWASAKI	ER-6N/Z 800/Z 1000	2007	2016	green - verde	FC070_GR	145,00
KAWASAKI	ER-6N/Z 800/Z 1000	2007	2016	orange - arancio	FC070_OR	145,00
KAWASAKI	ER-6N/Z 800/Z 1000	2007	2016	red - rosso	FC070_RE	145,00
KAWASAKI	ER-6N/Z 800/Z 1000	2007	2016	silver - argento	FC070_SI	145,00

BRAND	MODEL - MODELLO	FROM - DAL	TO - AL	COLOUR- COLORE	CODE - CODICE	€
KAWASAKI	Z650 (2017/2024) / Z900 (2017/2025)			black - nero	FC170_BK	118,00
KAWASAKI	Z650 (2017/2024) / Z900 (2017/2025)			blue - blu	FC170_BL	145,00
KAWASAKI	Z650 (2017/2024) / Z900 (2017/2025)			bronze - bronzo	FC170_BR	145,00
KAWASAKI	Z650 (2017/2024) / Z900 (2017/2025)			gold - oro	FC170_GO	145,00
KAWASAKI	Z650 (2017/2024) / Z900 (2017/2025)			green - verde	FC170_GR	145,00
KAWASAKI	Z650 (2017/2024) / Z900 (2017/2025)			orange - arancio	FC170_OR	145,00
KAWASAKI	Z650 (2017/2024) / Z900 (2017/2025)			red - rosso	FC170_RE	145,00
KAWASAKI	Z650 (2017/2024) / Z900 (2017/2025)			silver - argento	FC170_SI	145,00

KTM	RC 390/390 Duke/790-890 Duke	2018	2023	black - nero	FC200_BK	118,00
KTM	RC 390/390 Duke/790-890 Duke	2018	2023	blue - blu	FC200_BL	145,00
KTM	RC 390/390 Duke/790-890 Duke	2018	2023	bronze - bronzo	FC200_BR	145,00
KTM	RC 390/390 Duke/790-890 Duke	2018	2023	gold - oro	FC200_GO	145,00
KTM	RC 390/390 Duke/790-890 Duke	2018	2023	green - verde	FC200_GR	145,00
KTM	RC 390/390 Duke/790-890 Duke	2018	2023	orange - arancio	FC200_OR	145,00
KTM	RC 390/390 Duke/790-890 Duke	2018	2023	red - rosso	FC200_RE	145,00
KTM	RC 390/390 Duke/790-890 Duke	2018	2023	silver - argento	FC200_SI	145,00

KTM	1290 Super Duke R	2013	2023	black - nero	FC210_BK	118,00
KTM	1290 Super Duke R	2013	2023	blue - blu	FC210_BL	145,00
KTM	1290 Super Duke R	2013	2023	bronze - bronzo	FC210_BR	145,00
KTM	1290 Super Duke R	2013	2023	gold - oro	FC210_GO	145,00
KTM	1290 Super Duke R	2013	2023	green - verde	FC210_GR	145,00
KTM	1290 Super Duke R	2013	2023	orange - arancio	FC210_OR	145,00
KTM	1290 Super Duke R	2013	2023	red - rosso	FC210_RE	145,00
KTM	1290 Super Duke R	2013	2023	silver - argento	FC210_SI	145,00

MV AGUSTA	F3 675/800 - Brutale 675/800	2011	2018	black - nero	FC090_BK	118,00
MV AGUSTA	F3 675/800 - Brutale 675/800	2011	2018	blue - blu	FC090_BL	145,00
MV AGUSTA	F3 675/800 - Brutale 675/800	2011	2018	bronze - bronzo	FC090_BR	145,00
MV AGUSTA	F3 675/800 - Brutale 675/800	2011	2018	gold - oro	FC090_GO	145,00
MV AGUSTA	F3 675/800 - Brutale 675/800	2011	2018	green - verde	FC090_GR	145,00
MV AGUSTA	F3 675/800 - Brutale 675/800	2011	2018	orange - arancio	FC090_OR	145,00
MV AGUSTA	F3 675/800 - Brutale 675/800	2011	2018	red - rosso	FC090_RE	145,00
MV AGUSTA	F3 675/800 - Brutale 675/800	2011	2018	silver - argento	FC090_SI	145,00

MV AGUSTA	F4 - Brutale	1997	2009	black - nero	FC190_BK	118,00
MV AGUSTA	F4 - Brutale	1997	2009	blue - blu	FC190_BL	145,00
MV AGUSTA	F4 - Brutale	1997	2009	bronze - bronzo	FC190_BR	145,00
MV AGUSTA	F4 - Brutale	1997	2009	gold - oro	FC190_GO	145,00
MV AGUSTA	F4 - Brutale	1997	2009	green - verde	FC190_GR	145,00
MV AGUSTA	F4 - Brutale	1997	2009	orange - arancio	FC190_OR	145,00
MV AGUSTA	F4 - Brutale	1997	2009	red - rosso	FC190_RE	145,00
MV AGUSTA	F4 - Brutale	1997	2009	silver - argento	FC190_SI	145,00

PRICES WITHOUT VAT - PREZZI IVA ESCLUSA

TANK CAPS - TAPPI SERBATOIO

BRAND	MODEL - MODELLO	FROM - DAL	TO - AL	COLOUR - COLORE	CODE - CODICE	€
MV AGUSTA	F4 - Brutale	2010	2019	black - nero	FC130_BK	118,00
MV AGUSTA	F4 - Brutale	2010	2019	blue - blu	FC130_BL	145,00
MV AGUSTA	F4 - Brutale	2010	2019	bronze - bronzo	FC130_BR	145,00
MV AGUSTA	F4 - Brutale	2010	2019	gold - oro	FC130_GO	145,00
MV AGUSTA	F4 - Brutale	2010	2019	green - verde	FC130_GR	145,00
MV AGUSTA	F4 - Brutale	2010	2019	orange - arancio	FC130_OR	145,00
MV AGUSTA	F4 - Brutale	2010	2019	red - rosso	FC130_RE	145,00
MV AGUSTA	F4 - Brutale	2010	2019	silver - argento	FC130_SI	145,00

SUZUKI	GSX-R 600/750	2004	2018	black - nero	FC080_BK	118,00
SUZUKI	GSX-R 600/750	2004	2018	blue - blu	FC080_BL	145,00
SUZUKI	GSX-R 600/750	2004	2018	bronze - bronzo	FC080_BR	145,00
SUZUKI	GSX-R 600/750	2004	2018	gold - oro	FC080_GO	145,00
SUZUKI	GSX-R 600/750	2004	2018	green - verde	FC080_GR	145,00
SUZUKI	GSX-R 600/750	2004	2018	orange - arancio	FC080_OR	145,00
SUZUKI	GSX-R 600/750	2004	2018	red - rosso	FC080_RE	145,00
SUZUKI	GSX-R 600/750	2004	2018	silver - argento	FC080_SI	145,00

SUZUKI	GSX-R 1000	2003	2025	black - nero	FC080_BK	118,00
SUZUKI	GSX-R 1000	2003	2025	blue - blu	FC080_BL	145,00
SUZUKI	GSX-R 1000	2003	2025	bronze - bronzo	FC080_BR	145,00
SUZUKI	GSX-R 1000	2003	2025	gold - oro	FC080_GO	145,00
SUZUKI	GSX-R 1000	2003	2025	green - verde	FC080_GR	145,00
SUZUKI	GSX-R 1000	2003	2025	orange - arancio	FC080_OR	145,00
SUZUKI	GSX-R 1000	2003	2025	red - rosso	FC080_RE	145,00
SUZUKI	GSX-R 1000	2003	2025	silver - argento	FC080_SI	145,00

SUZUKI	GSX-S 750 (2015/2024)	GSX-S 1000 (2021/2025)		black - nero	FC080_BK	118,00
SUZUKI	GSX-S 750 (2015/2024)	GSX-S 1000 (2021/2025)		blue - blu	FC080_BL	145,00
SUZUKI	GSX-S 750 (2015/2024)	GSX-S 1000 (2021/2025)		bronze - bronzo	FC080_BR	145,00
SUZUKI	GSX-S 750 (2015/2024)	GSX-S 1000 (2021/2025)		gold - oro	FC080_GO	145,00
SUZUKI	GSX-S 750 (2015/2024)	GSX-S 1000 (2021/2025)		green - verde	FC080_GR	145,00
SUZUKI	GSX-S 750 (2015/2024)	GSX-S 1000 (2021/2025)		orange - arancio	FC080_OR	145,00
SUZUKI	GSX-S 750 (2015/2024)	GSX-S 1000 (2021/2025)		red - rosso	FC080_RE	145,00
SUZUKI	GSX-S 750 (2015/2024)	GSX-S 1000 (2021/2025)		silver - argento	FC080_SI	145,00

SUZUKI	GSX-8S/8R	2023	2025	black - nero	FC080_BK	118,00
SUZUKI	GSX-8S/8R	2023	2025	blue - blu	FC080_BL	145,00
SUZUKI	GSX-8S/8R	2023	2025	bronze - bronzo	FC080_BR	145,00
SUZUKI	GSX-8S/8R	2023	2025	gold - oro	FC080_GO	145,00
SUZUKI	GSX-8S/8R	2023	2025	green - verde	FC080_GR	145,00
SUZUKI	GSX-8S/8R	2023	2025	orange - arancio	FC080_OR	145,00
SUZUKI	GSX-8S/8R	2023	2025	red - rosso	FC080_RE	145,00
SUZUKI	GSX-8S/8R	2023	2025	silver - argento	FC080_SI	145,00

BRAND	MODEL - MODELLO	FROM - DAL	TO - AL	COLOUR - COLORE	CODE - CODICE	€
TRIUMPH	Street Triple - Daytona - Speed Triple* (all M.Y.)	-	-	black - nero	FC220_BK	118,00
TRIUMPH	Street Triple - Daytona - Speed Triple* (all M.Y.)	-	-	blue - blu	FC220_BL	145,00
TRIUMPH	Street Triple - Daytona - Speed Triple* (all M.Y.)	-	-	bronze - bronzo	FC220_BR	145,00
TRIUMPH	Street Triple - Daytona - Speed Triple* (all M.Y.)	-	-	gold - oro	FC220_GO	145,00
TRIUMPH	Street Triple - Daytona - Speed Triple* (all M.Y.)	-	-	green - verde	FC220_GR	145,00
TRIUMPH	Street Triple - Daytona - Speed Triple* (all M.Y.)	-	-	orange - arancio	FC220_OR	145,00
TRIUMPH	Street Triple - Daytona - Speed Triple* (all M.Y.)	-	-	red - rosso	FC220_RE	145,00
TRIUMPH	Street Triple - Daytona - Speed Triple* (all M.Y.)	-	-	silver - argento	FC220_SI	145,00

YAMAHA	YZF R3	2015	2025	black - nero	FC110_BK	118,00
YAMAHA	YZF R3	2015	2025	blue - blu	FC110_BL	145,00
YAMAHA	YZF R3	2015	2025	bronze - bronzo	FC110_BR	145,00
YAMAHA	YZF R3	2015	2025	gold - oro	FC110_GO	145,00
YAMAHA	YZF R3	2015	2025	green - verde	FC110_GR	145,00
YAMAHA	YZF R3	2015	2025	orange - arancio	FC110_OR	145,00
YAMAHA	YZF R3	2015	2025	red - rosso	FC110_RE	145,00
YAMAHA	YZF R3	2015	2025	silver - argento	FC110_SI	145,00

YAMAHA	YZF R6 - YZF R1/R1M	1998	2025	black - nero	FC110_BK	118,00
YAMAHA	YZF R6 - YZF R1/R1M	1998	2025	blue - blu	FC110_BL	145,00
YAMAHA	YZF R6 - YZF R1/R1M	1998	2025	bronze - bronzo	FC110_BR	145,00
YAMAHA	YZF R6 - YZF R1/R1M	1998	2025	gold - oro	FC110_GO	145,00
YAMAHA	YZF R6 - YZF R1/R1M	1998	2025	green - verde	FC110_GR	145,00
YAMAHA	YZF R6 - YZF R1/R1M	1998	2025	orange - arancio	FC110_OR	145,00
YAMAHA	YZF R6 - YZF R1/R1M	1998	2025	red - rosso	FC110_RE	145,00
YAMAHA	YZF R6 - YZF R1/R1M	1998	2025	silver - argento	FC110_SI	145,00

YAMAHA	MT-03/MT-07 (- /2024) - MT-09 (2021/2025)			black - nero	FC110_BK	118,00
YAMAHA	MT-03/MT-07 (- /2024) - MT-09 (2021/2025)			blue - blu	FC110_BL	145,00
YAMAHA	MT-03/MT-07 (- /2024) - MT-09 (2021/2025)			bronze - bronzo	FC110_BR	145,00
YAMAHA	MT-03/MT-07 (- /2024) - MT-09 (2021/2025)			gold - oro	FC110_GO	145,00
YAMAHA	MT-03/MT-07 (- /2024) - MT-09 (2021/2025)			green - verde	FC110_GR	145,00
YAMAHA	MT-03/MT-07 (- /2024) - MT-09 (2021/2025)			orange - arancio	FC110_OR	145,00
YAMAHA	MT-03/MT-07 (- /2024) - MT-09 (2021/2025)			red - rosso	FC110_RE	145,00
YAMAHA	MT-03/MT-07 (- /2024) - MT-09 (2021/2025)			silver - argento	FC110_SI	145,00

YAMAHA	YZF R7 (2021/2025) - YZF R9 (2025/2025)			black - nero	FC110_BK	118,00
YAMAHA	YZF R7 (2021/2025) - YZF R9 (2025/2025)			blue - blu	FC110_BL	145,00
YAMAHA	YZF R7 (2021/2025) - YZF R9 (2025/2025)			bronze - bronzo	FC110_BR	145,00
YAMAHA	YZF R7 (2021/2025) - YZF R9 (2025/2025)			gold - oro	FC110_GO	145,00
YAMAHA	YZF R7 (2021/2025) - YZF R9 (2025/2025)			green - verde	FC110_GR	145,00
YAMAHA	YZF R7 (2021/2025) - YZF R9 (2025/2025)			orange - arancio	FC110_OR	145,00
YAMAHA	YZF R7 (2021/2025) - YZF R9 (2025/2025)			red - rosso	FC110_RE	145,00
YAMAHA	YZF R7 (2021/2025) - YZF R9 (2025/2025)			silver - argento	FC110_SI	145,00

* not compatible with the Speed Triple 1200 RS 2021/2024 and Speed Triple 1200 RR 2022/2024 models
* non compatibile con i modelli Speed Triple 1200 RS 2021/2024 e Speed Triple 1200 RR 2022/2024

PRICES WITHOUT VAT - PREZZI IVA ESCLUSA

BONAMICI RACING MERCHANDISING



PRICES WITHOUT VAT - PREZZI IVA ESCLUSA

DESCRIPTION - DESCRIZIONE	CODE - CODICE	€	SIZE - TAGLIA
T-SHIRT	TSH01	34,00	S - M - L - XL - XXL



DESCRIPTION - DESCRIZIONE	CODE - CODICE	€
Cap - Cappello	CAP01	27,00





BONAMICI RACING MERCHANDISING



DESCRIPTION - DESCRIZIONE

CODE - CODICE

€

Brake fluid reservoir sock cover
Polsino serbatoio Liquido Freno

PLS01

10,00



DESCRIPTION - DESCRIZIONE

CODE - CODICE

€

Rubber key ring Bonamici Racing Logo
Portachiavi in gomma Logo Bonamici Racing

KRG01

8,00







INDEX MODELS - INDICE MODELLI

APRILIA RSV4 (2021/2024)	106
APRILIA RSV4 (2017/2020)	107
APRILIA RS 660 / TUONO 660 (2020/2025)	108
BMW S 1000 RR (2017/2018)	109
BMW S 1000 RR (2019/ 2022)	110
BMW S 1000 RR (2023/2025)	111
BMW M 1000 RR (2021/2025)	112
BMW S 1000 R - M 1000 R (2021/2025)	113
BMW S 1000 XR (2020/2025)	114
DUCATI 899/959/1199/1299 PANIGALE	115
DUCATI PANIGALE V2	116
DUCATI PANIGALE V4/V4S/V4R (2018/2024)	117
DUCATI PANIGALE V4/V4S (2025)	118
DUCATI STREETFIGHTER V2 (2022/2024)	119
DUCATI STREETFIGHTER V4/V4S (2020/2024)	120
DUCATI STREETFIGHTER V4/V4S (2025/2025)	121
HONDA CBR 1000 RR-R FIREBLADE (2020/2025)	122
HONDA CBR 600 RR (2024/2025)	123
KAWASAKI ZX-10R (2016/2020)	124
KAWASAKI ZX-10R (2021/2025)	125
KAWASAKI ZX-4RR (2023/2025)	126
KAWASAKI ZX-6R (2024/2025)	127
KAWASAKI Z900 (2017/2025)	128
KTM 790/890 DUKE	129
KTM 1290 SUPER DUKE R (2020/2023)	130
KTM 1390 SUPER DUKE R (2024/2025)	131
SUZUKI GSX-R 1000 (2017/2025)	132
SUZUKI GSX-S 1000 (2021/2025)	133
SUZUKI GSX-8R (2023/2025)	134
SUZUKI GSX-8S (2023/2025)	135
TRIUMPH STREET TRIPLE (2017/2022)	136
TRIUMPH STREET TRIPLE 765 R (2023/2025)	137
TRIUMPH STREET TRIPLE 765 RS/MOTO 2 EDITION (2023/2025)	138
TRIUMPH SPEED TRIPLE 1200 RS (2021/2025)	139
TRIUMPH SPEED TRIPLE 1200 RR (2022/2025)	140
YAMAHA YZF R1 (2015/2019)	141
YAMAHA YZF R1 (2020/2025)	142
YAMAHA YZF R3 (2015/2025)	143
YAMAHA YZF R6 (2017/2025)	144
YAMAHA YZF R7 (2021/2025)	145
NEW YAMAHA YZF R9 (2025/2025)	146
YAMAHA MT-09 (2021/2025)	147



DESCRIPTION - DESCRIZIONE

CODE - CODICE €

Rearsets(standard shifting) - Pedane (cambio normale)	A005S	598,00
Rearsets(reverse shifting) - Pedane (cambio rovesciato)	A005SR	598,00
Engine protections - Protezioni motore	CP107	377,00
Dashboard protection - Protezione strumentazione	DCP13	201,00
Raised Clip-ons - Semimanubri rialzati	SM51A	267,00
Top triple clamp "Standard" - Piastra di sterzo superiore "Standard"	PSA1	426,00
Top triple clamp "Race" - Piastra di sterzo superiore "Race"	PSA1R	349,00
Brake lever - Leva freno	LB110	161,00
Brake lever with remote adjuster - Leva freno con registro a sx	RALB110	279,00
Clutch lever - Leva frizione	LC010	128,00
Complete Clutch lever - Leva frizione completa	LCF	190,00
Adjustable Complete Clutch lever - Leva frizione completa regolabile	LCFR	254,00
Levers kit - Kit leve	KL010	272,00
EVO lever protection (without adaptor) - Protezione leva EVO (senza adattatore)	LPRR2_BK	199,00
Lever protection (without adaptor) - Protezione leva (senza adattatore)	LPRR_B_BK	111,00
Carbon lever protection (without adaptor) - Protezione leva in carbonio (senza adattatore)	LPLITE1_R	251,00
Tank cap (black) - Tappo serbatoio (nero)	FC030_BK	118,00
10 ml Rear brake fluid reservoirs - Serbatoio fluido freno posteriore 10 ml	VS10P_BK	120,00
30 ml front fluid reservoir - Serbatoio fluido anteriore 30 ml	VS40_BK	196,00
Chain adjuster - Tencatena	CHAD13_BK	274,00
Swingarms spools - Supporti cavalletto	SCS6_BK	51,00
Swingarms spools "racing" - Supporti cavalletto "racing"	SCR6_BK	64,00



DESCRIPTION - DESCRIZIONE

CODE - CODICE €

Rearsets (standard shifting) - Pedane (cambio standard)	A005S	598,00
Rearsets (reverse shifting) - Pedane (cambio rovesciato)	A005SR	598,00
Dashboard protection - Protezione strumentazione	DCP06	201,00
Non-raised Clip-ons - Semimanubri bassi	SM51B	267,00
Raised Clip-ons - Semimanubri rialzati	SM51	267,00
Top triple clamp "Standard" - Piastra di sterzo superiore "Standard"	PSA1	426,00
Top triple clamp "Race" - Piastra di sterzo superiore "Race"	PSA1R	349,00
Brake lever - Leva freno	LB110	161,00
Brake lever with remote adjuster - Leva freno con registro a sx	RALB110	279,00
Clutch lever - Leva frizione	LC010	128,00
Complete Clutch lever - Leva frizione completa	LCF	190,00
Adjustable Complete Clutch lever - Leva frizione completa regolabile	LCFR	254,00
Levers kit - Kit leve	KL010	272,00
EVO lever protection (without adaptor) - Protezione leva EVO (senza adattatore)	LPRR2_BK	199,00
Lever protection (without adaptor) Protezione leva (senza adattatore)	LPRR_B_BK	111,00
Carbon lever protection (without adaptor) - Protezione leva in carbonio (senza adattatore)	LPLITE1_R	251,00
Tank cap (black) - Tappo serbatoio (nero)	FC030_BK	118,00
10 ml Rear brake fluid reservoirs - Serbatoio fluido freno posteriore 10 ml	VS10P_BK	120,00
30 ml front fluid reservoir - Serbatoio fluido anteriore 30 ml	VS40_BK	196,00
Chain adjuster - Tendicatena	CHAD04_BK	274,00
Swingarms spools - Supporti cavalletto	SCS6_BK	51,00
Swingarms spools "racing" - Supporti cavalletto "racing"	SCR6_BK	64,00



Some items can be purchased in colors other than standard black - Alcuni articoli possono essere acquistati in colori diversi dal nero standard

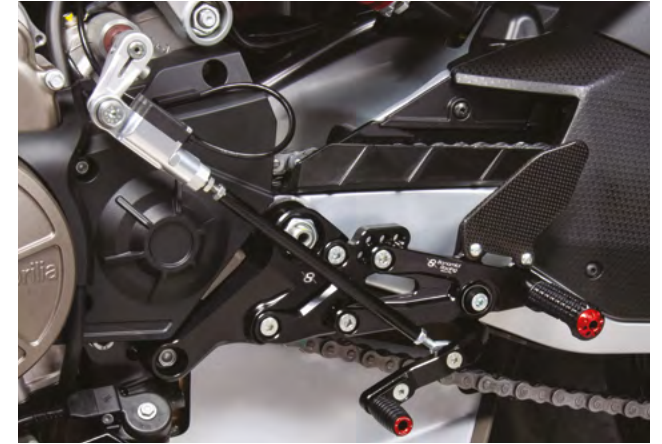

DESCRIPTION - DESCRIZIONE

CODE - CODICE €

Rearsets- Pedane	A006	779,00
Dashboard protection - Protezione strumentazione	DCP12	201,00
Raised Clip-ons (only for RS 660) - Semimanubri rialzati (solo per RS 660)	SM51A	267,00
Steering stops - Coppia battute di sterzo	BS02	69,00
Top triple clamp (only for RS 660) - Piastra di sterzo superiore (solo per RS 660)	PSA2	502,00
Engine protections - Protezioni motore	CP114	481,00
Brake lever - Leva freno	LB110	161,00
Brake lever with remote adjuster - Leva freno con registro a sx	RALB110	279,00
Clutch lever - Leva frizione	LC010	128,00
Complete Clutch lever - Leva frizione completa	LCF	190,00
Adjustable Complete Clutch lever - Leva frizione completa regolabile	LCFR	254,00
Levers kit - Kit leve	KL010	272,00
EVO lever protection (without adaptor) - Protezione leva EVO (senza adattatore)	LPRR2_BK	199,00
Lever protection (without adaptor) - Protezione leva (senza adattatore)	LPRR_B_BK	111,00
Carbon lever protection (without adaptor) - Protezione leva in carbonio (senza adattatore)	LPLITE1_R	251,00
Tank cap (black) - Tappo serbatoio (nero)	FC090_BK	118,00
10 ml Rear brake fluid reservoirs - Serbatoio fluido freno posteriore 10 ml	VS10P_BK	120,00
30 ml front fluid reservoir - Serbatoio fluido anteriore 30 ml	VS40_BK	196,00
Chain adjuster - Tencicatena	CHAD12_BK	274,00
Swingarms spools - Supporti cavalletto	SCS6_BK	51,00
Swingarms spools "racing" - Supporti cavalletto "racing"	SCR6_BK	64,00
Oil cap - Tappo olio	T011_BK	39,00



DESCRIPTION - DESCRIZIONE

CODE - CODICE €

Rearsets - Pedane	B005	524,00
Top triple clamp "Standard" - Piastra di sterzo superiore "Standard"	PSB1	421,00
Top triple clamp "Race" - Piastra di sterzo superiore "Race"	PSB1R	349,00
Non-raised Clip-ons - Semimanubri bassi	SM55B	267,00
Raised Clip-ons - Semimanubri rialzati	SM55	267,00
Brake lever - Leva freno	LB090	161,00
Brake lever with remote adjuster - Leva freno con registro a sx	RALB090	279,00
Clutch lever - Leva frizione	LC140	143,00
Complete Clutch lever - Leva frizione completa	LCF	190,00
Adjustable Complete Clutch lever - Leva frizione completa regolabile	LCFR	254,00
Levers kit - Kit leve	KL220	286,00
EVO lever protection (without adaptor) - Protezione leva EVO (senza adattatore)	LPRR2_BK	199,00
Lever protection (without adaptor) Protezione leva (senza adattatore)	LPRR_B_BK	111,00
Carbon lever protection (without adaptor) - Protezione leva in carbonio (senza adattatore)	LPLITE1_R	251,00
Tank cap - Tappo serbatoio	FC040	118,00
10 ml Rear brake fluid reservoirs - Serbatoio fluido freno posteriore 10 ml	VS10P_BK	120,00
30 ml front fluid reservoir - Serbatoio fluido anteriore 30 ml	VS40_BK	196,00
Chain adjuster - Tenticatena	CHAD01_BK	274,00
Swingarms spools - Supporti cavalletto	SCS8_BK	51,00
Swingarms spools "racing" - Supporti cavalletto "racing"	SCR8_BK	64,00
Oil cap - Tappo olio	T004_BK	39,00



Some items can be purchased in colors other than standard black - Alcuni articoli possono essere acquistati in colori diversi dal nero standard

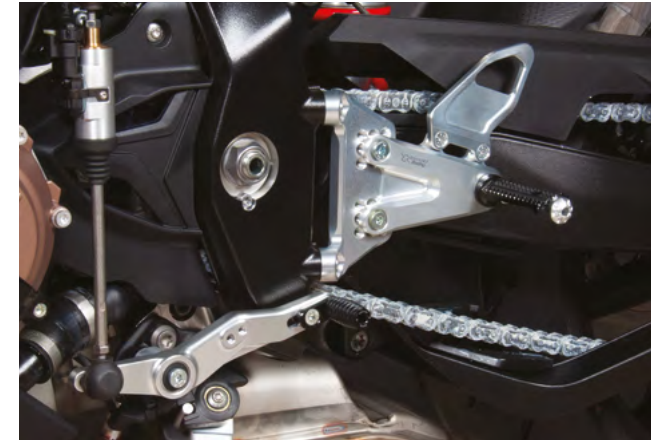

* Clip-ons to use the OEM triple clamp (include the steering plate bracelets)
 * Semimanubri utilizzabili con la piastra di sterzo originale (Include i bracciali per la piastra di sterzo)
 ** Clip-ons to use with Bonamici Racing top triple clamp (not include the clamps for steering plate)
 ** Semimanubri utilizzabili con la piastra di sterzo Bonamici Racing (non Include la coppia di supporti ad arco per la piastra di sterzo)
 *** The brake lever may touch with the knob on the instrument frame, when the motorcycle is understeer.
 The plastic protection cannot be remounted on the clutch lever.
 *** La leva freno quando la moto è sottosterzo, potrebbe toccare con il pomello sul telaio porta strumentazione.
 Non è possibile rimontare la protezione in plastica sulla leva frizione.

DESCRIPTION - DESCRIZIONE

CODE - CODICE €

Rearsets- Pedane	B007	699,00
Top triple clamp "Standard"- Piastra di sterzo superiore "Standard"	PSB2	421,00
Top triple clamp "Race"- Piastra di sterzo superiore "Race"	PSB2R	349,00
Engine protections "racing" 5 pcs. - Protezioni motore "racing" 5pz.	CP086B	571,00
Raised Clip-ons* - Semimanubri rialzati*	SM55S1K	391,00
Raised Clip-ons** - Semimanubri rialzati**	SM55S1KW	267,00
Brake lever*** - Leva freno***	LB090	161,00
Brake lever with remote adjuster - Leva freno con registro a sx	RALB090	279,00
Clutch lever*** - Leva frizione***	LC170	143,00
Complete Clutch lever - Leva frizione completa	LCF	190,00
Adjustable Complete Clutch lever - Leva frizione completa regolabile	LCFR	254,00
Levers kit*** - Kit leve***	KL290	286,00
EVO lever protection (without adaptor) - Protezione leva EVO (senza adattatore)	LPRR2_BK	199,00
Lever protection (without adaptor) Protezione leva (senza adattatore)	LPRR_B_BK	111,00
Carbon lever protection (without adaptor) - Protezione leva in carbonio (senza adattatore)	LPLITE1_R	251,00
Dashboard protection - Protezione strumentazione	DCP08	201,00
Tank cap (black) - Tappo serbatoio (nero)	FC040_BK	118,00
10 ml Rear brake fluid reservoirs - Serbatoio fluido freno posteriore 10 ml	VS10P_BK	120,00
30 ml front fluid reservoir - Serbatoio fluido anteriore 30 ml	VS40_BK	196,00
Oil cap - Tappo olio	T004_BK	39,00
Chain adjuster - Tendicatena	CHAD09_BK	274,00
Swingarms spools - Supporti cavalletto	SCS8_BK	51,00
Swingarms spools "racing" - Supporti cavalletto "racing"	SCR8_BK	64,00
Block mirror - Tappi specchio	BM07_BK	69,00
Gear spacer support - Supporto distanziale cambio	DC_039B	95,00

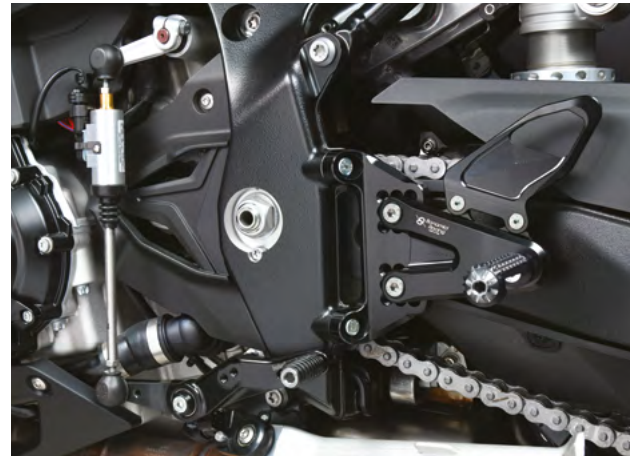

DESCRIPTION - DESCRIZIONE

CODE - CODICE €

Rearsets- Pedane	B007	699,00
Top triple clamp "Standard"- Piastra di sterzo superiore "Standard"	PSB3	421,00
Top triple clamp "Race" - Piastra di sterzo superiore "Race"	PSB3R	349,00
Engine protections "racing" 5 pcs. - Protezioni motore "racing" 5pz.	CP086B	571,00
Raised Clip-ons* - Semimanubri rialzati*	SM55S1K	391,00
Raised Clip-ons** - Semimanubri rialzati**	SM55S1KW	267,00
Brake lever*** - Leva freno***	LB090	161,00
Brake lever with remote adjuster - Leva freno con registro a sx	RALB090	279,00
Clutch lever*** - Leva frizione***	LC170	143,00
Complete Clutch lever - Leva frizione completa	LCF	190,00
Adjustable Complete Clutch lever - Leva frizione completa regolabile	LCFR	254,00
Levers kit*** - Kit leve***	KL290	286,00
EVO lever protection (without adaptor) - Protezione leva EVO (senza adattatore)	LPRR2_BK	199,00
Lever protection (without adaptor) Protezione leva (senza adattatore)	LPRR_B_BK	111,00
Carbon lever protection (without adaptor) - Protezione leva in carbonio (senza adattatore)	LPLITE1_R	251,00
Dashboard protection - Protezione strumentazione	DCP08	201,00
Tank cap (black) - Tappo serbatoio (nero)	FC040_BK	118,00
10 ml Rear brake fluid reservoirs - Serbatoio fluido freno posteriore 10 ml	VS10P_BK	120,00
30 ml front fluid reservoir - Serbatoio fluido anteriore 30 ml	VS40_BK	196,00
Oil cap - Tappo olio	T004_BK	39,00
Chain adjuster - Tendicatena	CHAD09_BK	274,00
Swingarms spools - Supporti cavalletto	SCS8_BK	51,00
Swingarms spools "racing" - Supporti cavalletto "racing"	SCR8_BK	64,00
Block mirror - Tappi specchio	BM07_BK	69,00
Gear spacer support - Supporto distanziale cambio	DC_039B	95,00



* Clip-ons to use the OEM triple clamp (include the steering plate bracelets)

* Semimanubri utilizzabili con la piastra di sterzo originale (Include i bracciali per la piastra di sterzo)

** Clip-ons to use with Bonamici Racing top triple clamp (not include the clamps for steering plate)

** Semimanubri utilizzabili con la piastra di sterzo Bonamici Racing (non Include la coppia di supporti ad arco per la piastra di sterzo)

*** The brake lever may touch with the knob on the instrument frame, when the motorcycle is understeer.

The plastic protection cannot be remounted on the clutch lever.

*** La leva freno quando la moto è sottosterzo, potrebbe toccare con il pomello sul telaio porta strumentazione.

Non è possibile rimontare la protezione in plastica sulla leva frizione.

Some items can be purchased in colors other than standard black - Alcuni articoli possono essere acquistati in colori diversi dal nero standard

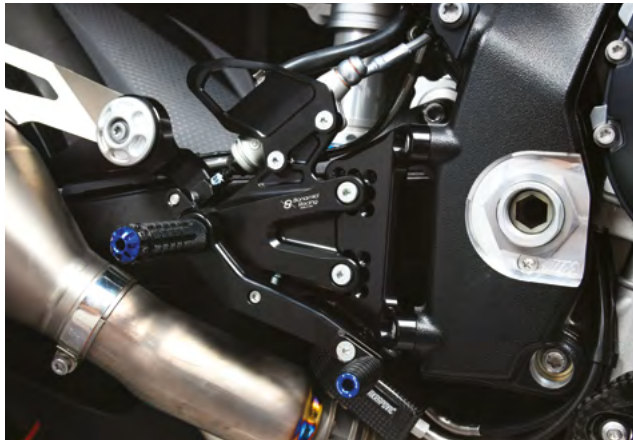

* Clip-ons to use the OEM triple clamp (include the steering plate bracelets)

* Semimanubri utilizzabili con la piastra di sterzo originale (Include i bracciali per la piastra di sterzo)

** Clip-ons to use with Bonamici Racing top triple clamp (not include the clamps for steering plate)

** Semimanubri utilizzabili con la piastra di sterzo Bonamici Racing (non Include la coppia di supporti ad arco per la piastra di sterzo)

*** The brake lever may touch with the knob on the instrument frame, when the motorcycle is understeer.

The plastic protection cannot be remounted on the clutch lever.

*** La leva freno quando la moto è sottosterzo, potrebbe toccare con il pomello sul telaio porta strumentazione.

Non è possibile rimontare la protezione in plastica sulla leva frizione.

DESCRIPTION - DESCRIZIONE

CODE - CODICE €

Rearsets- Pedane	B007	699,00
Top triple clamp "Standard"- Piastra di sterzo superiore "Standard"	PSB3	421,00
Top triple clamp "Race"- Piastra di sterzo superiore "Race"	PSB3R	349,00
Engine protections "racing" 5 pcs. - Protezioni motore "racing" 5pz. (2021-2024 models)	CP086B	571,00
Raised Clip-ons* - Semimanubri rialzati*	SM55S1K	391,00
Raised Clip-ons** - Semimanubri rialzati**	SM55S1KW	267,00
Brake lever*** - Leva freno***	LB090	161,00
Brake lever with remote adjuster - Leva freno con registro a sx	RALB090	279,00
Clutch lever*** - Leva frizione***	LC170	143,00
Complete Clutch lever - Leva frizione completa	LCF	190,00
Adjustable Complete Clutch lever - Leva frizione completa regolabile	LCFR	254,00
Levers kit*** - Kit leve***	KL290	286,00
EVO lever protection (without adaptor) - Protezione leva EVO (senza adattatore)	LPRR2_BK	199,00
Lever protection (without adaptor) - Protezione leva (senza adattatore)	LPRR_B_BK	111,00
Carbon lever protection (without adaptor) - Protezione leva in carbonio (senza adattatore)	LPLITE1_R	251,00
Dashboard protection - Protezione strumentazione (2021-2022 models)	DCP08	201,00
Tank cap (black) - Tappo serbatoio (nero)	FC040_BK	118,00
10 ml Rear brake fluid reservoirs - Serbatoio fluido freno posteriore 10 ml	VS10P_BK	120,00
30 ml front fluid reservoir - Serbatoio fluido anteriore 30 ml	VS40_BK	196,00
Oil cap - Tappo olio	T004_BK	39,00
Swingarms spools "racing" - Supporti cavalletto "racing"	SCR8_BK	64,00
Gear spacer support - Supporto distanziale cambio	DC_039B	95,00

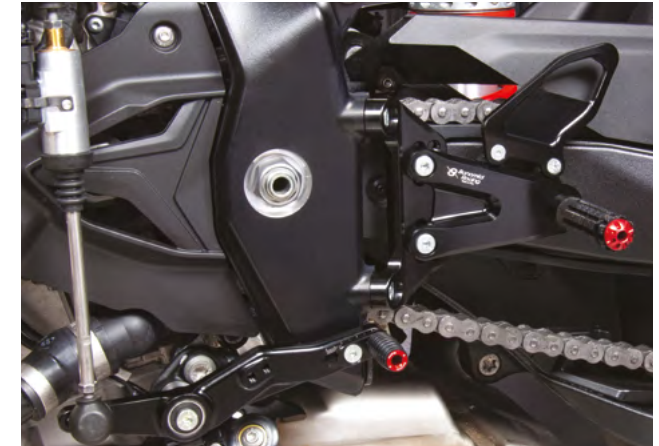

DESCRIPTION - DESCRIZIONE

CODE - CODICE

€

Rearsets- Pedane	B008	699,00
Engine protections "racing" 5 pcs. - Protezioni motore "racing" 5pz.	CP086B	571,00
Brake lever - Leva freno	LB200	161,00
Brake lever with remote adjuster - Leva freno con registro a sx	RALB200	279,00
Clutch lever - Leva frizione *	LC170	143,00
Complete Clutch lever - Leva frizione completa	LCF	190,00
Adjustable Complete Clutch lever - Leva frizione completa regolabile	LCFR	254,00
Levers kit - Kit leve *	KL270	286,00
Dashboard protection - Protezione strumentazione	DCP08	201,00
Tank cap (black) - Tappo serbatoio (nero)	FC040_BK	118,00
10 ml Rear brake fluid reservoirs - Serbatoio fluido freno posteriore 10 ml	VS10P_BK	120,00
30 ml front fluid reservoir - Serbatoio fluido anteriore 30 ml	VS40_BK	196,00
Oil cap - Tappo olio	T004_BK	39,00
Chain adjuster - Tendicatena	CHAD09_BK	274,00
Swingarms spools - Supporti cavalletto	SCS8_BK	51,00
Swingarms spools "racing" - Supporti cavalletto "racing"	SCR8_BK	64,00
Gear spacer support - Supporto distanziale cambio	DC_039B	95,00

* The plastic protection cannot be remounted on the clutch lever.
* Non è possibile rimontare la protezione in plastica sulla leva frizione.



Some items can be purchased in colors other than standard black - Alcuni articoli possono essere acquistati in colori diversi dal nero standard

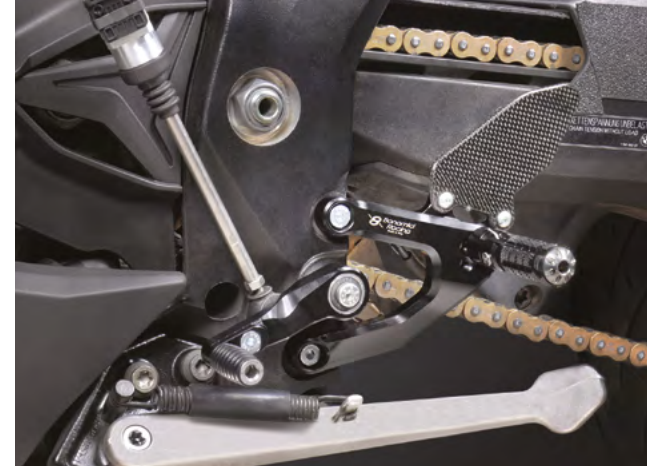

DESCRIPTION - DESCRIZIONE

CODE - CODICE

€

Rearsets- Pedane	B009	713,00
Engine protections 4pcs. - Protezioni motore 4pz.	CP116	494,00
Brake lever - Leva freno	LB200	161,00
Clutch lever - Leva frizione *	LC170	143,00
Levers kit - Kit leve *	KL270	286,00
Dashboard protection - Protezione strumentazione	DCP08	201,00
Oil cap - Tappo olio	T004_BK	39,00
Chain adjuster with integrated EVO standard swingarms spools Tendicatena con supporto cavalletto standard EVO integrato	CHAD15_BK	317,00
10 ml Rear brake fluid reservoirs - Serbatoio fluido freno posteriore 10 ml	VS10P_BK	120,00
30 ml front fluid reservoir - Serbatoio fluido anteriore 30 ml	VS40_BK	196,00

* The plastic protection cannot be remounted on the clutch lever.

* Non è possibile rimontare la protezione in plastica sulla leva frizione.



DESCRIPTION - DESCRIZIONE

CODE - CODICE €

Rearsets- Pedane	DV2	671,00
Engine protections (for 959) - Protezioni motore (per 959)	CP009B	389,00
Engine protections (for 1199/1299) - Protezioni motore (per1199/1299)	CP009A	389,00
Non-raised Clip-ons ø53mm - Semimanubri bassi ø53mm	SM53B	267,00
Non-raised Clip-ons for 1199S - Semimanubri bassi per 1199S	SM53PA	328,00
Raised Clip-ons ø53mm - Semimanubri rialzati ø53mm	SM53	267,00
Brake lever - Leva freno	LB140	161,00
Brake lever with remote adjuster - Leva freno con registro a sx	RALB140	279,00
Clutch lever - Leva frizione	LC061	157,00
Levers kit - Kit leve	KL031	300,00
EVO lever protection (without adaptor) - Protezione leva EVO (senza adattatore)	LPRR2_BK	199,00
Lever protection (without adaptor) Protezione leva (senza adattatore)	LPRR_B_BK	111,00
Carbon lever protection (without adaptor) - Protezione leva in carbonio (senza adattatore)	LPLITE1_R	251,00
Tank cap (black) - Tappo serbatoio (nero)	FC050_BK	118,00
Oil cap (899/1199) - Tappo olio (899/1199)	T008_BK	39,00
Oil cap (1299) - Tappo olio (1299)	T003_BK	39,00
10 ml Rear brake fluid reservoirs - Serbatoio fluido freno posteriore 10 ml	VS10P_BK	120,00
30 ml front fluid reservoir - Serbatoio fluido anteriore 30 ml	VS40_BK	196,00



Some items can be purchased in colors other than standard black - Alcuni articoli possono essere acquistati in colori diversi dal nero standard

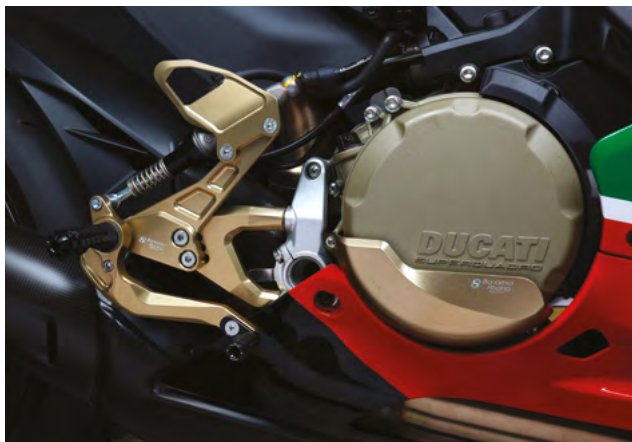

DESCRIPTION - DESCRIZIONE

CODE - CODICE €

Rearsets- Pedane (2020-2024 models)	DV2	671,00
Engine protections - Protezioni motore (2020-2024 models)	CP105	389,00
Engine protections - Protezioni motore "Racing" * (2020-2024 models)	CP122	473,00
Clip-ons with steering dumper bracket Semimanubri con bracciale per ammortizzatore di sterzo (2020-2024 models)	SM53PV2	328,00
Top triple clamp - Piastra di sterzo superiore (2020-2024 models)	PSV2	526,00
Dashboard protection - Protezione strumentazione (2020-2024 models)	DCP11	188,00
Levers kit - Kit leve (2020-2022 models)	KL031	300,00
Brake lever - Leva freno (2020-2022 models)	LB140	161,00
Brake lever with remote adjuster - Leva freno con registro a sx (2020-2022 models)	RALB140	279,00
Levers kit - Kit leve (2023- 2024 models)	KL380	300,00
Brake lever - Leva freno (2023- 2024 models)	LB240	61,00
Brake lever with remote adjuster - Leva freno con registro a sx (2023- 2024 models)	RALB240	279,00
Clutch lever - Leva frizione (2020-2024 models)	LC061	157,00
EVO lever protection (without adaptor) Protezione leva EVO (senza adattatore) (2020-2024 models)	LPRR2_BK	199,00
Lever protection (without adaptor) Protezione leva (senza adattatore) (2020-2024 models)	LPRR_B_BK	111,00
Carbon lever protection (without adaptor) Protezione leva in carbonio (senza adattatore) (2020-2024 models)	LPLITE1_R	251,00
Tank cap - Tappo serbatoio (2020-2024 models)	FC050_BK	118,00
10 ml Rear brake fluid reservoirs - Serbatoio fluido freno posteriore 10 ml (2020-2024 models)	VS10P_BK	120,00
30 ml front fluid reservoir - Serbatoio fluido anteriore 30 ml (2020-2024 models)	VS40_BK	196,00
Oil cap - Tappo olio (2020-2024 models)	T003_BK	39,00
Block mirror - Tappi specchio (2020-2024 models)	BM06_BK	69,00

* Installation is possible only on racing racing fairings - * L'installazione è possibile solo su carene racing

Some items can be purchased in colors other than standard black - Alcuni articoli possono essere acquistati in colori diversi dal nero standard



DESCRIPTION - DESCRIZIONE

CODE - CODICE €

Rearsets- Pedane (2018-2024 models)	DV4	800,00
Engine protections - Protezioni motore (V4/V4S) (2018-2024 models)	CP081	377,00
Engine protections - Protezioni motore (V4R) (2018-2024 models)	CP081B	377,00
Clip-ons with steering dumper bracket (V4/V4S) Semimanubri con bracciale per ammortizzatore di sterzo (V4/V4S) (2018-2024 models)	SM53PV4	343,00
Clip-ons with steering dumper bracket (V4R) Semimanubri con bracciale per ammortizzatore di sterzo (V4R) (2018-2024 models)	SM53PV4R	343,00
Top triple clamp - Piastra di sterzo superiore (V4/V4S 2018-2024 models) (V4R 2019-2022 models)	PSV4	526,00
Dashboard protection - Protezione strumentazione (2018-2024 models)	DCP03	188,00
Brake lever - Leva freno (2018-2022 models)	LB140	161,00
Brake lever - Leva freno (2023 - 2024 models)	LB240	161,00
Brake lever with remote adjuster - Leva freno con registro a sx (2018 - 2022 models)	RALB140	279,00
Brake lever with remote adjuster - Leva freno con registro a sx (2023 - 2024 models)	RALB240	279,00
Brake lever with racing remote adjuster - Leva freno con registro racing a sx (2018 - 2022 models)	RALB140R	396,00
Brake lever with racing remote adjuster - Leva freno con registro racing a sx (2023 - 2024 models)	RALB240R	396,00
Clutch lever - Leva frizione (2018 - 2024 models)	LC061	157,00
Levers kit - Kit leve (2018-2022 models)	KL031	300,00
Levers kit - Kit leve (2023- 2024 models)	KL380	300,00
EVO lever protection (without adaptor) - Protezione leva EVO (senza adattatore) (2018- 2024 models)	LPRR2_BK	199,00
Lever protection (without adaptor) Protezione leva (senza adattatore) (2018- 2024 models)	LPRR_B_BK	111,00
Carbon lever protection (without adaptor) Protezione leva in carbonio (senza adattatore) (2018- 2024 models)	LPLITE1_R	251,00
Tank cap (black) - Tappo serbatoio (nero) (2018- 2024 models)	FC050_BK	118,00
10 ml Rear brake fluid reservoirs - Serbatoio fluido freno posteriore 10 ml (2018- 2024 models)	VS10P_BK	120,00
30 ml front fluid reservoir - Serbatoio fluido anteriore 30 ml (2018-2024 models)	VS40_BK	196,00
Oil cap - Tappo olio (2018- 2024 models)	T008_BK	39,00
Block mirror - Tappi specchio (2018-2024 models)	BM06_BK	69,00



Some items can be purchased in colors other than standard black - Alcuni articoli possono essere acquistati in colori diversi dal nero standard



DESCRIPTION - DESCRIZIONE

CODE - CODICE €

Rearsets- Pedane	D001	960,00
Engine protections - Protezioni motore	CP127	377,00
Clip-ons with steering dumper bracket Semimanubri con bracciale per ammortizzatore di sterzo	SM53C_V4	343,00
Top triple clamp - Piastra di sterzo superiore	PSD1	452,00
Dashboard protection - Protezione strumentazione	DCP25	209,00
Brake lever - Leva freno	LB270	161,00
Brake lever with remote adjuster - Leva freno con registro a sx	RALB240	279,00
Brake lever with racing remote adjuster - Leva freno con registro racing a sx	RALB240R	396,00
Clutch lever - Leva frizione	LC260	157,00
Levers kit - Kit leve	KL450	300,00
EVO lever protection (without adaptor) - Protezione leva EVO (senza adattatore)	LPRR2_BK	199,00
Lever protection (without adaptor) Protezione leva (senza adattatore)	LPRR_B_BK	111,00
Carbon lever protection (without adaptor) Protezione leva in carbonio (senza adattatore)	LPLITE1_R	251,00
Tank cap (black) - Tappo serbatoio (nero)	FC050_BK	118,00
Oil cap - Tappo olio	T008_BK	39,00
Swingarms spools - Supporti cavalletto	SCS8_BK	51,00
Swingarms spools "racing" - Supporti cavalletto "racing"	SCR8_BK	64,00
30 ml front fluid reservoir - Serbatoio fluido anteriore 30 ml	VS40_BK	196,00



DESCRIPTION - DESCRIZIONE

CODE - CODICE €

Rearsets- Pedane	DSTR3	715,00
Dashboard protection - Protezione strumentazione	DCP11	188,00
Brake lever - Leva freno	LB240	161,00
Brake lever with remote adjuster - Leva freno con registro a sx	RALB240	279,00
Brake lever with racing remote adjuster - Leva freno con registro racing a sx	RALB240R	396,00
Clutch lever - Leva frizione	LC061	157,00
Levers kit - Kit leve	KL380	300,00
EVO lever protection (without adaptor) - Protezione leva EVO (senza adattatore)	LPRR2_BK	199,00
Lever protection (without adaptor) Protezione leva (senza adattatore)	LPRR_B_BK	111,00
Carbon lever protection (without adaptor) - Protezione leva in carbonio (senza adattatore)	LPLITE1_R	251,00
Tank cap - Tappo serbatoio	FC050_BK	118,00
10 ml Rear brake fluid reservoirs - Serbatoio fluido freno posteriore 10 ml	VS10P_BK	120,00
30 ml front fluid reservoir - Serbatoio fluido anteriore 30 ml	VS40_BK	196,00
Oil cap - Tappo olio	T003_BK	39,00



Some items can be purchased in colors other than standard black - Alcuni articoli possono essere acquistati in colori diversi dal nero standard

DUCATI STREETFIGHTER V4/V4S 2020/2024



DESCRIPTION - DESCRIZIONE

CODE - CODICE

€

Rearsets- Pedane	DSTR2	800,00
Engine protections - Protezioni motore (2020-2022)	CP103	455,00
Engine protections - Protezioni motore (2023-2024)	CP081	377,00
Dashboard protection - Protezione strumentazione	DCP10	188,00
Brake lever - Leva freno (2020 / 2022 models)	LB140	161,00
Brake lever - Leva freno (2023 / 2024 models)	LB240	161,00
Brake lever with remote adjuster - Leva freno con registro a sx (2020 / 2022 models)	RALB140	279,00
Brake lever with remote adjuster - Leva freno con registro a sx (2023 / 2024 models)	RALB240	279,00
Clutch lever - Leva frizione	LC061	157,00
Levers kit - Kit leve (2020 / 2022 models)	KL031	300,00
Levers kit - Kit leve (2023 / 2024 models)	KL380	300,00
EVO lever protection (without adaptor) - Protezione leva EVO (senza adattatore)	LPRR2_BK	199,00
Lever protection (without adaptor) - Protezione leva (senza adattatore)	LPRR_B_BK	111,00
Carbon lever protection (without adaptor) - Protezione leva in carbonio (senza adattatore)	LPLITE1_R	251,00
Tank cap (black) - Tappo serbatoio (nero)	FC050_BK	118,00
10 ml Rear brake fluid reservoirs - Serbatoio fluido freno posteriore 10 ml	VS10P_BK	120,00
30 ml front fluid reservoir - Serbatoio fluido anteriore 30 ml	VS40_BK	196,00
Oil cap - Tappo olio	T008_BK	39,00



DESCRIPTION - DESCRIZIONE

CODE - CODICE €

Rearsets- Pedane	D002	960,00
Engine protections - Protezioni motore	CP129	377,00
Dashboard protection - Protezione strumentazione	DCP25	209,00
Brake lever - Leva freno	LB240	161,00
Brake lever with remote adjuster - Leva freno con registro a sx	RALB240	279,00
Brake lever with racing remote adjuster - Leva freno con registro racing a sx	RALB240R	396,00
Clutch lever - Leva frizione	LC061	157,00
Levers kit - Kit leve	KL380	300,00
EVO lever protection (without adaptor) - Protezione leva EVO (senza adattatore)	LPRR2_BK	199,00
Lever protection (without adaptor) Protezione leva (senza adattatore)	LPRR_B_BK	111,00
Carbon lever protection (without adaptor) Protezione leva in carbonio (senza adattatore)	LPLITE1_R	251,00
Tank cap (black) - Tappo serbatoio (nero)	FC050_BK	118,00
Oil cap - Tappo olio	T008_BK	39,00
Swingarms spools - Supporti cavalletto	SCS8_BK	51,00
Swingarms spools "racing" - Supporti cavalletto "racing"	SCR8_BK	64,00
30 ml front fluid reservoir - Serbatoio fluido anteriore 30 ml	VS40_BK	196,00



Some items can be purchased in colors other than standard black - Alcuni articoli possono essere acquistati in colori diversi dal nero standard

HONDA CBR 1000 RR-R FIREBLADE 2020/2025

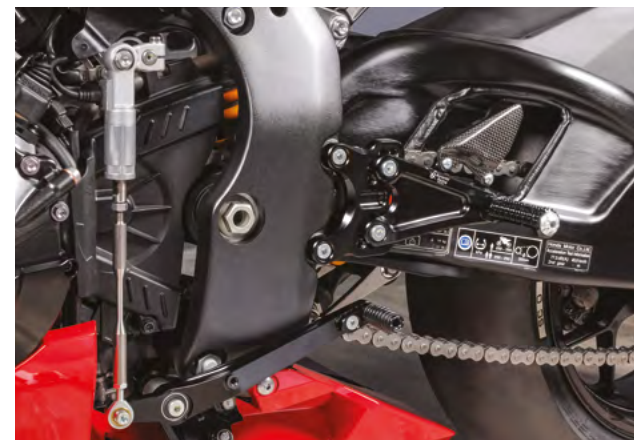

DESCRIPTION - DESCRIZIONE

CODE - CODICE €

Rearsets "Racing" - Pedane "Racing"	H015	591,00
Rearsets "Standard" - Pedane "Standard"	H016	631,00

DESCRIPTION - DESCRIZIONE

CODE - CODICE €

Gear spacer support - Supporto distanziale cambio	DC_040B	108,00
Engine protections - Protezioni motore	CP100	481,00
Non-raised Clip-ons - Semimanubri bassi	SM50B	267,00
Top triple clamp - Piastra di sterzo superiore	PSH2	502,00
Brake lever - Leva freno	LB150	161,00
Brake lever (for SP model) - Leva freno (per modello SP)	LB110	161,00
Brake lever with remote adjuster - Leva freno con registro a sx	RALB150	279,00
Brake lever with remote adj. (SP) - Leva freno con registro a sx (SP)	RALB110	279,00
Clutch lever - Leva frizione	LC020	128,00
Complete Clutch lever - Leva frizione completa	LCF	190,00
Adjustable Complete Clutch lever - Leva frizione completa regolabile	LCFR	254,00
Levers kit - Kit leve	KL040	272,00
Levers kit (for SP model) - Kit leve (per modello SP)	KL310	272,00
EVO lever protection (without adaptor) - Protezione leva EVO (senza adattatore)	LPRR2_BK	199,00
Lever protection (without adaptor) - Protezione leva (senza adattatore)	LPRR_B_BK	111,00
Carbon lever protection (without adaptor) - Protezione leva in carbonio (senza adattatore)	LPLITE1_R	251,00
Tank cap (black) - Tappo serbatoio (nero)	FC120_BK	118,00
Oil cap - Tappo olio	T003_BK	39,00
10 ml Rear brake fluid reservoirs - Serbatoio fluido freno posteriore 10 ml	VS10P_BK	120,00
30 ml front fluid reservoir - Serbatoio fluido anteriore 30 ml	VS40_BK	196,00
Chain adjuster - Tendicatena	CHAD10_BK	274,00
Dashboard protection - Protezione strumentazione	DCP09	191,00
Swingarms spools - Supporti cavalletto	SCS8_BK	51,00
Swingarms spools "racing" - Supporti cavalletto "racing"	SCR8_BK	64,00

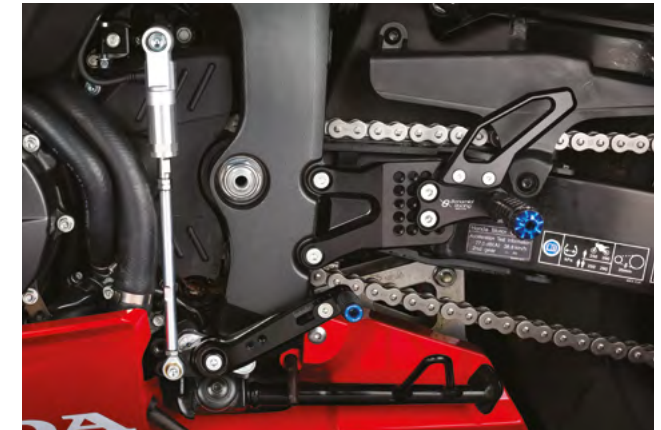

DESCRIPTION - DESCRIZIONE

CODE - CODICE €

Rearsets- Pedane	H018	539,00
Raised Clip-ons - Semimanubri rialzati	SM48	267,00
Brake lever - Leva freno	LB150	161,00
Brake lever with remote adjuster - Leva freno con registro a sx	RALB150	279,00
Clutch lever - Leva frizione	LC020	128,00
Complete Clutch lever - Leva frizione completa	LCF	190,00
Adjustable Complete Clutch lever - Leva frizione completa regolabile	LCFR	254,00
Levers kit - Kit leve	KL040	272,00
Dashboard protection - Protezione strumentazione	DCP23	193,00
EVO lever protection (without adaptor) - Protezione leva EVO (senza adattatore)	LPRR2_BK	199,00
Lever protection (without adaptor) - Protezione leva (senza adattatore)	LPRR_B_BK	111,00
Carbon lever protection (without adaptor) - Protezione leva in carbonio (senza adattatore)	LPLITE1_R	251,00
Tank cap - Tappo serbatoio	FC160_BK	118,00
Oil cap - Tappo olio	T003_BK	39,00
Chain adjuster - Tendicatena	CHAD14_BK	274,00
10 ml Rear brake fluid reservoirs - Serbatoio fluido freno posteriore 10 ml	VS10P_BK	120,00
30 ml front fluid reservoir - Serbatoio fluido anteriore 30 ml	VS40_BK	196,00
Swingarms spools - Supporti cavalletto	SCS8_BK	51,00
Swingarms spools "racing" - Supporti cavalletto "racing"	SCR8_BK	64,00





DESCRIPTION - DESCRIZIONE

CODE - CODICE €

Rearsets - Pedane	K021	699,00
Engine protections - Protezioni motore	CP012	273,00
Non-raised Clip-ons - Semimanubri bassi	SM50B	267,00
Raised Clip-ons - Semimanubri rialzati	SM50	267,00
Top triple clamp "Standard" - Piastra di sterzo superiore "Standard"	PSK1	398,00
Top triple clamp "Race" - Piastra di sterzo superiore "Race"	PSK1R	374,00
Brake lever - Leva freno	LB110	161,00
Brake lever with remote adjuster - Leva freno con registro a sx	RALB110	279,00
Clutch lever - Leva frizione	LC040	128,00
Complete Clutch lever - Leva frizione completa	LCF	190,00
Adjustable Complete Clutch lever - Leva frizione completa regolabile	LCFR	254,00
Levers kit - Kit leve	KL210	272,00
EVO lever protection (without adaptor) - Protezione leva EVO (senza adattatore)	LPRR2_BK	199,00
Lever protection (without adaptor) - Protezione leva (senza adattatore)	LPRR_B_BK	111,00
Carbon lever protection (without adaptor) - Protezione leva in carbonio (senza adattatore)	LPLITE1_R	251,00
Tank cap (black) - Tappo serbatoio (nero)	FC070_BK	118,00
Oil cap - Tappo olio	T002_BK	39,00
10 ml Rear brake fluid reservoirs - Serbatoio fluido freno posteriore 10 ml	VS10P_BK	120,00
30 ml front fluid reservoir - Serbatoio fluido anteriore 30 ml	VS40_BK	196,00
Chain adjuster - Tencatena	CHAD02_BK	274,00
Swingarms spools - Supporti cavalletto	SCS8_BK	51,00
Swingarms spools "racing" - Supporti cavalletto "racing"	SCR8_BK	64,00

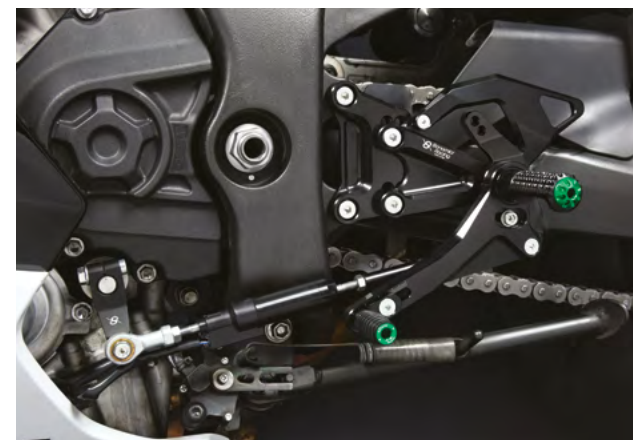

DESCRIPTION - DESCRIZIONE

CODE - CODICE €

Rearsets - Pedane	K021	699,00
Engine protections - Protezioni motore	CP012	273,00
Non-raised Clip-ons - Semimanubri bassi	SM50B	267,00
Raised Clip-ons - Semimanubri rialzati	SM50	267,00
Dashboard protection - Protezione strumentazione	DCP20	216,00
Top triple clamp "Standard" - Piastra di sterzo superiore "Standard"	PSK3	398,00
Top triple clamp "Race" - Piastra di sterzo superiore "Race"	PSK3R	374,00
Brake lever - Leva freno	LB110	161,00
Brake lever with remote adjuster - Leva freno con registro a sx	RALB110	279,00
Brake lever with Racing remote adjuster - Leva freno con registro Racing a sx	RALB110R	396,00
Clutch lever - Leva frizione	LC040	128,00
Complete Clutch lever - Leva frizione completa	LCF	190,00
Adjustable Complete Clutch lever - Leva frizione completa regolabile	LCFR	254,00
Levers kit - Kit leve	KL210	272,00
EVO lever protection (without adaptor) - Protezione leva EVO (senza adattatore)	LPRR2_BK	199,00
Lever protection (without adaptor) - Protezione leva (senza adattatore)	LPRR_B_BK	111,00
Carbon lever protection (without adaptor) - Protezione leva in carbonio (senza adattatore)	LPLITE1_R	251,00
Tank cap (black) - Tappo serbatoio (nero)	FC170_BK	118,00
Oil cap - Tappo olio	T002_BK	39,00
10 ml Rear brake fluid reservoirs - Serbatoio fluido freno posteriore 10 ml	VS10P_BK	120,00
30 ml front fluid reservoir - Serbatoio fluido anteriore 30 ml	VS40_BK	196,00
Chain adjuster - Tencicatena	CHAD02_BK	274,00
Swingarms spools - Supporti cavalletto	SCS8_BK	51,00
Swingarms spools "racing" - Supporti cavalletto "racing"	SCR8_BK	64,00



Some items can be purchased in colors other than standard black - Alcuni articoli possono essere acquistati in colori diversi dal nero standard



DESCRIPTION - DESCRIZIONE

CODE - CODICE €

Rearsets - Pedane	K022	699,00
Raised Clip-ons - Semimanubri rialzati	SM45A	267,00
Dashboard protection - Protezione strumentazione	DCP20	216,00
Top triple clamp - Piastra di sterzo superiore	PSK2	398,00
Brake lever - Leva freno	LB260	161,00
Brake lever with remote adjuster - Leva freno con registro a sx	RALB260	279,00
Brake lever with Racing remote adjuster - Leva freno con registro Racing a sx	RALB260R	396,00
Clutch lever - Leva frizione	LC240	157,00
Complete Clutch lever - Leva frizione completa	LCF	190,00
Adjustable Complete Clutch lever - Leva frizione completa regolabile	LCFR	254,00
Levers kit - Kit leve	KL410	300,00
EVO lever protection (without adaptor) - Protezione leva EVO (senza adattatore)	LPRR2_BK	199,00
Lever protection (without adaptor) - Protezione leva (senza adattatore)	LPRR_B_BK	111,00
Carbon lever protection (without adaptor) - Protezione leva in carbonio (senza adattatore)	LPLITE1_R	251,00
Tank cap (black) - Tappo serbatoio (nero)	FC170_BK	118,00
Oil cap - Tappo olio	T008_BK	39,00
10 ml Rear brake fluid reservoirs - Serbatoio fluido freno posteriore 10 ml	VS10P_BK	120,00
30 ml front fluid reservoir - Serbatoio fluido anteriore 30 ml	VS40_BK	196,00
Swingarms spools - Supporti cavalletto	SCS8_BK	51,00
Swingarms spools "racing" - Supporti cavalletto "racing"	SCR8_BK	64,00



DESCRIPTION - DESCRIZIONE

CODE - CODICE €

Rearsets- Pedane	K024	635,00
Raised Clip-ons - Semimanubri rialzati	SM50A	267,00
Dashboard protection - Protezione strumentazione	DCP20	216,00
Top triple clamp "Standard" - Piastra di sterzo superiore "Standard"	PSK4	421,00
Top triple clamp "Race" - Piastra di sterzo superiore "Race"	PSK4R	349,00
Brake lever - Leva freno	LB160	161,00
Brake lever with racing remote adjuster - Leva freno con registro remoto racing	RALB160R	396,00
Clutch lever - Leva frizione	LC240	157,00
Complete Clutch lever - Leva frizione completa	LCF	190,00
Adjustable Complete Clutch lever - Leva frizione completa regolabile	LCFR	254,00
Levers kit - Kit leve	KL440	300,00
EVO lever protection (without adaptor) - Protezione leva EVO (senza adattatore)	LPRR2_BK	199,00
Lever protection (without adaptor) - Protezione leva (senza adattatore)	LPRR_B_BK	111,00
Carbon lever protection (without adaptor) - Protezione leva in carbonio (senza adattatore)	LPLITE1_R	251,00
Tank cap (black) - Tappo serbatoio (nero)	FC170_BK	118,00
Oil cap - Tappo olio	T002_BK	39,00
Chain adjuster - Tendicatena	CHAD16_BK	274,00
Chain adjuster with caliper support - Tendicatena con supporto pinza	CHAD16P_BK	323,00
10 ml Rear brake fluid reservoirs - Serbatoio fluido freno posteriore 10 ml	VS10P_BK	120,00
30 ml front fluid reservoir - Serbatoio fluido anteriore 30 ml	VS40_BK	196,00
Swingarms spools - Supporti cavalletto	SCS8_BK	51,00
Swingarms spools "racing" - Supporti cavalletto "racing"	SCR8_BK	64,00



Some items can be purchased in colors other than standard black - Alcuni articoli possono essere acquistati in colori diversi dal nero standard



DESCRIPTION - DESCRIZIONE

CODE - CODICE €

Rearsets- Pedane	K023B	471,00
Dashboard protection - Protezione strumentazione (2020/2024)	DCP24	237,00
Brake lever - Leva freno	LB260	161,00
Clutch lever - Leva frizione	LC240	157,00
Complete Clutch lever - Leva frizione completa	LCF	190,00
Adjustable Complete Clutch lever - Leva frizione completa regolabile	LCFR	254,00
Levers kit - Kit leve	KL410	300,00
EVO lever protection (without adaptor) - Protezione leva EVO (senza adattatore)	LPRR2_BK	199,00
Lever protection (without adaptor) - Protezione leva (senza adattatore)	LPRR_B_BK	111,00
Carbon lever protection (without adaptor) - Protezione leva in carbonio (senza adattatore)	LPLITE1_R	251,00
10 ml Rear brake fluid reservoirs - Serbatoio fluido freno posteriore 10 ml	VS10P_BK	120,00
30 ml front fluid reservoir - Serbatoio fluido anteriore 30 ml	VS40_BK	196,00
Swingarms spools - Supporti cavalletto	SCS8_BK	51,00
Swingarms spools "racing" - Supporti cavalletto "racing"	SCR8_BK	64,00

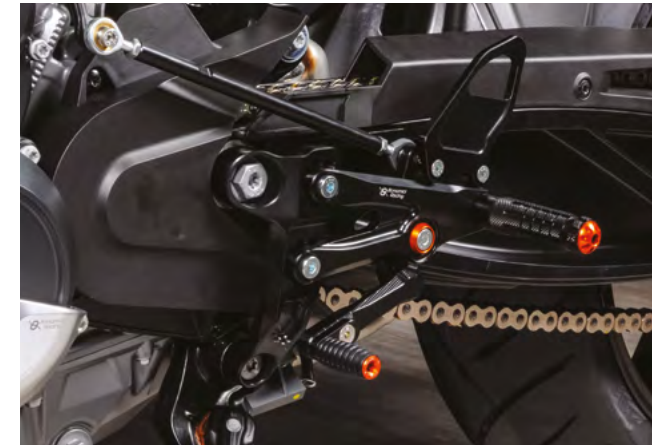

DESCRIPTION - DESCRIZIONE

CODE - CODICE €

Rearsets- Pedane	KT04	549,00
Engine protections - Protezioni motore (Duke 890) *	CP093B	377,00
Levers kit - Kit leve	KL300	286,00
Brake lever - Leva freno	LB190	161,00
Clutch lever - Leva frizione	LC180	143,00
EVO lever protection (without adaptor) - Protezione leva EVO (senza adattatore)	LPRR2_BK	199,00
Lever protection (without adaptor) - Protezione leva (senza adattatore)	LPRR_B_BK	111,00
Carbon lever protection (without adaptor) - Protezione leva in carbonio (senza adattatore)	LPLITE1_R	251,00
Tank cap (black) - Tappo serbatoio (nero)	FC200_BK	118,00
10 ml Rear brake fluid reservoirs - Serbatoio fluido freno posteriore 10 ml	VS10P_BK	120,00
30 ml front fluid reservoir - Serbatoio fluido anteriore 30 ml	VS40_BK	196,00
Swingarm spools M10 x 1,5 - Supporti cavalletto M10 x 1,5	SCS10G_BK	51,00
Swingarm spools M10 x 1,5 "racing" - Supporti cavalletto M10 x 1,5 "racing"	SCR10G_BK	64,00

(*) Availability is limited; this product will be supplied while stocks last
 (*) Disponibilità limitata: il prodotto sarà fornito fino ad esaurimento scorte.



Some items can be purchased in colors other than standard black - Alcuni articoli possono essere acquistati in colori diversi dal nero standard



DESCRIPTION - DESCRIZIONE

CODE - CODICE €

Rearsets- Pedane	KT06	561,00
Engine protections - Protezioni motore	CP060	344,00
Levers kit - Kit leve	KL280	286,00
Brake lever - Leva freno	LB110	161,00
Clutch lever - Leva frizione	LC200	143,00
Complete Clutch lever - Leva frizione completa	LCF	190,00
Adjustable Complete Clutch lever - Leva frizione completa regolabile	LCFR	254,00
EVO lever protection (without adaptor) - Protezione leva EVO (senza adattatore)	LPRR2_BK	199,00
Lever protection (without adaptor) - Protezione leva (senza adattatore)	LPRR_B_BK	111,00
Carbon lever protection (without adaptor) - Protezione leva in carbonio (senza adattatore)	LPLITE1_R	251,00
Tank cap (nero) - Tappo serbatoio (nero)	FC210_BK	118,00
10 ml Rear brake fluid reservoirs - Serbatoio fluido freno posteriore 10 ml	VS10P_BK	120,00
30 ml front fluid reservoir - Serbatoio fluido anteriore 30 ml	VS40_BK	196,00



DESCRIPTION - DESCRIZIONE

CODE - CODICE €

Rearsets- Pedane	KT06	561,00
Engine protections - Protezioni motore	CP124	355,00
Levers kit - Kit leve	KL420	300,00
Brake lever - Leva freno	LB210	161,00
Clutch lever - Leva frizione	LC061	157,00
EVO lever protection (without adaptor) - Protezione leva EVO (senza adattatore)	LPRR2_BK	199,00
Lever protection (without adaptor) - Protezione leva (senza adattatore)	LPRR_B_BK	111,00
Carbon lever protection (without adaptor) - Protezione leva in carbonio (senza adattatore)	LPLITE1_R	251,00
10 ml Rear brake fluid reservoirs - Serbatoio fluido freno posteriore 10 ml	VS10P_BK	120,00
30 ml front fluid reservoir - Serbatoio fluido anteriore 30 ml	VS40_BK	196,00



Some items can be purchased in colors other than standard black - Alcuni articoli possono essere acquistati in colori diversi dal nero standard



DESCRIPTION - DESCRIZIONE

CODE - CODICE €

Rearsets- Pedane	S011	531,00
Engine protections - Protezioni motore	CP070	416,00
Non-raised Clip-ons - Semimanubri bassi	SM50B	267,00
Raised Clip-ons - Semimanubri rialzati	SM50	267,00
Dashboard protection - Protezione strumentazione	DCP05	201,00
Top triple clamp "Standard" - Piastra di sterzo superiore "Standard"	PSS1	398,00
Top triple clamp "Race" - Piastra di sterzo superiore "Race"	PSS1R	349,00
Brake lever - Leva freno	LB090	161,00
Brake lever with remote adjuster - Leva freno con registro a sx	RALB090	279,00
Clutch lever - Leva frizione	LC090	128,00
Complete Clutch lever - Leva frizione completa	LCF	190,00
Adjustable Complete Clutch lever - Leva frizione completa regolabile	LCFR	254,00
Levers kit - Kit leve	KL170	272,00
EVO lever protection (without adaptor) - Protezione leva EVO (senza adattatore)	LPRR2_BK	199,00
Lever protection (without adaptor) - Protezione leva (senza adattatore)	LPRR_B_BK	111,00
Carbon lever protection (without adaptor) - Protezione leva in carbonio (senza adattatore)	LPLITE1_R	251,00
Tank cap (black) - Tappo serbatoio (nero)	FC080_BK	118,00
Oil cap - Tappo olio	T005_BK	39,00
10 ml Rear brake fluid reservoirs - Serbatoio fluido freno posteriore 10 ml	VS10P_BK	120,00
30 ml front fluid reservoir - Serbatoio fluido anteriore 30 ml	VS40_BK	196,00
Chain adjuster - Tendicatena	CHAD06_BK	274,00
Swingarms spools - Supporti cavalletto	SCS8_BK	51,00
Swingarms spools "racing" - Supporti cavalletto "racing"	SCR8_BK	64,00



DESCRIPTION - DESCRIZIONE

CODE - CODICE €

Brake lever - Leva freno	LB201	161,00
Brake lever with remote adjuster - Leva freno con registro a sx	RALB201	279,00
Clutch lever - Leva frizione	LC210	128,00
Levers kit - Kit leve	KL330	272,00
EVO lever protection (without adaptor) - Protezione leva EVO (senza adattatore)	LPRR2_BK	199,00
Lever protection (without adaptor) - Protezione leva (senza adattatore)	LPRR_B_BK	111,00
Carbon lever protection (without adaptor) - Protezione leva in carbonio (senza adattatore)	LPLITE1_R	251,00
Dashboard protection - Protezione strumentazione	DCP05	201,00
Tank cap (black) - Tappo serbatoio (nero)	FC080_BK	118,00
10 ml Rear brake fluid reservoirs - Serbatoio fluido freno posteriore 10 ml	VS10P_BK	120,00
30 ml front fluid reservoir - Serbatoio fluido anteriore 30 ml	VS40_BK	196,00
Oil cap - Tappo olio	T005_BK	39,00
Chain adjuster - Tendicatena	CHAD06_BK	274,00
Swingarms spools - Supporti cavalletto	SCS8_BK	51,00
Swingarms spools "racing" - Supporti cavalletto "racing"	SCR8_BK	64,00



Some items can be purchased in colors other than standard black - Alcuni articoli possono essere acquistati in colori diversi dal nero standard

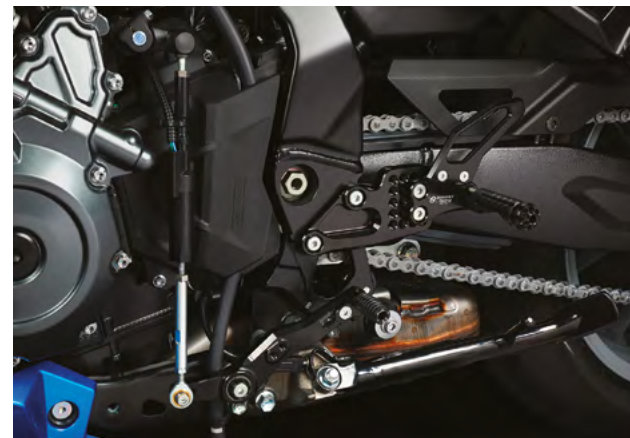

DESCRIPTION - DESCRIZIONE

CODE - CODICE €

Rearsets- Pedane	S014	501,00
Clip-ons - Semimanubri they include steering stop code BS04 and steering plate caps code TPS01 comprendono battuta di sterzo codice BS04 e tappi piastria di sterzo codice TPS01	SM50A8R	381,00
Brake lever - Leva freno	LB201	161,00
Brake lever with remote adjuster - Leva freno con registro a sx	RALB201	279,00
Clutch lever - Leva frizione	LC250	128,00
Complete Clutch lever - Leva frizione completa	LCF	190,00
Adjustable Complete Clutch lever - Leva frizione completa regolabile	LCFR	254,00
Levers kit - Kit leve	KL430	272,00
EVO lever protection (without adaptor) - Protezione leva EVO (senza adattatore)	LPRR2_BK	199,00
Lever protection (without adaptor) - Protezione leva (senza adattatore)	LPRR_B_BK	111,00
Carbon lever protection (without adaptor) - Protezione leva in carbonio (senza adattatore)	LPLITE1_R	251,00
Tank cap (black) - Tappo serbatoio (nero)	FC080_BK	118,00
Oil cap (black)- Tappo olio (nero)	T005_BK	39,00
10 ml Rear brake fluid reservoirs - Serbatoio fluido freno posteriore 10 ml	VS10P_BK	120,00
30 ml front fluid reservoir - Serbatoio fluido anteriore 30 ml	VS40_BK	196,00
Swingarms spools - Supporti cavalletto	SCS8_BK	51,00
Swingarms spools "racing" - Supporti cavalletto "racing"	SCR8_BK	64,00



DESCRIPTION - DESCRIZIONE

CODE - CODICE €

Rearsets- Pedane	S014	501,00
Brake lever - Leva freno	LB201	161,00
Brake lever with remote adjuster - Leva freno con registro a sx	RALB201	279,00
Clutch lever - Leva frizione	LC250	128,00
Complete Clutch lever - Leva frizione completa	LCF	190,00
Adjustable Complete Clutch lever - Leva frizione completa regolabile	LCFR	254,00
Levers kit - Kit leve	KL430	272,00
EVO lever protection (without adaptor) - Protezione leva EVO (senza adattatore)	LPRR2_BK	199,00
Lever protection (without adaptor) - Protezione leva (senza adattatore)	LPRR_B_BK	111,00
Carbon lever protection (without adaptor) - Protezione leva in carbonio (senza adattatore)	LPLITE1_R	251,00
Tank cap - Tappo serbatoio	FC080_BK	118,00
Oil cap (black)- Tappo olio (nero)	T005_BK	39,00
10 ml Rear brake fluid reservoirs - Serbatoio fluido freno posteriore 10 ml	VS10P_BK	120,00
30 ml front fluid reservoir - Serbatoio fluido anteriore 30 ml	VS40_BK	196,00
Swingarms spools - Supporti cavalletto	SCS8_BK	51,00
Swingarms spools "racing" - Supporti cavalletto "racing"	SCR8_BK	64,00



Some items can be purchased in colors other than standard black - Alcuni articoli possono essere acquistati in colori diversi dal nero standard



DESCRIPTION - DESCRIZIONE

CODE - CODICE €

Rearsets- Pedane	TH06	584,00
Engine protections - Protezioni motore	CP074	377,00
Complete Clutch lever - Leva frizione completa	LCF	190,00
Adjustable Complete Clutch lever - Leva frizione completa regolabile	LCFR	254,00
EVO lever protection (without adaptor) - Protezione leva EVO (senza adattatore)	LPRR2_BK	199,00
Lever protection (without adaptor) - Protezione leva (senza adattatore)	LPRR_B_BK	111,00
Carbon lever protection (without adaptor) - Protezione leva in carbonio (senza adattatore)	LPLITE1_R	251,00
Tank cap (black) - Tappo serbatoio (nero)	FC220_BK	118,00
Swingarms spools - Supporti cavalletto	SCS8_BK	51,00
Swingarms spools "racing" - Supporti cavalletto "racing"	SCR8_BK	64,00
10 ml Rear brake fluid reservoirs - Serbatoio fluido freno posteriore 10 ml	VS10P_BK	120,00
30 ml front fluid reservoir - Serbatoio fluido anteriore 30 ml	VS40_BK	196,00



DESCRIPTION - DESCRIZIONE

CODE - CODICE €

Rearsets- Pedane	TH09	584,00
Engine protections - Protezioni motore	CP074	377,00
Brake lever - Leva freno	LB200	161,00
Brake lever with remote adjuster - Leva freno con registro a sx	RALB200	279,00
Brake lever with Racing remote adjuster - Leva freno con registro Racing a sx	RALB200R	396,00
Clutch lever - Leva frizione	LC080	128,00
Complete Clutch lever - Leva frizione completa	LCF	190,00
Adjustable Complete Clutch lever - Leva frizione completa regolabile	LCFR	254,00
Levers kit - Kit leve	KL390	272,00
EVO lever protection (without adaptor) - Protezione leva EVO (senza adattatore)	LPRR2_BK	199,00
Lever protection (without adaptor) - Protezione leva (senza adattatore)	LPRR_B_BK	111,00
Carbon lever protection (without adaptor) - Protezione leva in carbonio (senza adattatore)	LPLITE1_R	251,00
Oil cap - Tappo olio	T009_BK	39,00
10 ml Rear brake fluid reservoirs - Serbatoio fluido freno posteriore 10 ml	VS10P_BK	120,00
30 ml front fluid reservoir - Serbatoio fluido anteriore 30 ml	VS40_BK	196,00
Tank cap - Tappo serbatoio	FC220_BK	118,00
Swingarms spools - Supporti cavalletto	SCS8_BK	51,00
Swingarms spools "racing" - Supporti cavalletto "racing"	SCR8_BK	64,00



Some items can be purchased in colors other than standard black - Alcuni articoli possono essere acquistati in colori diversi dal nero standard



DESCRIPTION - DESCRIZIONE

CODE - CODICE

€

Rearsets- Pedane	TH09	584,00
Engine protections - Protezioni motore	CP074	377,00
Brake lever - Leva freno	LB210	161,00
Brake lever with remote adjuster - Leva freno con registro a sx	RALB210	279,00
Brake lever with Racing remote adjuster - Leva freno con registro Racing a sx	RALB210R	396,00
Clutch lever - Leva frizione	LC230	143,00
Complete Clutch lever - Leva frizione completa	LCF	190,00
Adjustable Complete Clutch lever - Leva frizione completa regolabile	LCFR	254,00
Levers kit - Kit leve	KL360	286,00
EVO lever protection (without adaptor) - Protezione leva EVO (senza adattatore)	LPRR2_BK	199,00
Lever protection (without adaptor) - Protezione leva (senza adattatore)	LPRR_B_BK	111,00
Carbon lever protection (without adaptor) - Protezione leva in carbonio (senza adattatore)	LPLITE1_R	251,00
Oil cap - Tappo olio	T009_BK	39,00
10 ml Rear brake fluid reservoirs - Serbatoio fluido freno posteriore 10 ml	VS10P_BK	120,00
30 ml front fluid reservoir - Serbatoio fluido anteriore 30 ml	VS40_BK	196,00
Tank cap (black) - Tappo serbatoio (nero)	FC220_BK	118,00
Swingarms spools - Supporti cavalletto	SCS8_BK	51,00
Swingarms spools "racing" - Supporti cavalletto "racing"	SCR8_BK	64,00



DESCRIPTION - DESCRIZIONE

CODE - CODICE €

Rearsets- Pedane	TH08	596,00
Engine protections - Protezioni motore (M.Y. 2021-2024)	CP119	305,00
Brake lever - Leva freno	LB210	161,00
Brake lever with remote adjuster - Leva freno con registro a sx	RALB210	279,00
Brake lever with Racing remote adjuster - Leva freno con registro Racing a sx	RALB210R	396,00
Clutch lever - Leva frizione	LC230	143,00
Complete Clutch lever - Leva frizione completa	LCF	190,00
Adjustable Complete Clutch lever - Leva frizione completa regolabile	LCFR	254,00
Levers kit - Kit leve	KL360	286,00
EVO lever protection (without adaptor) - Protezione leva EVO (senza adattatore)	LPRR2_BK	199,00
Lever protection (without adaptor) - Protezione leva (senza adattatore)	LPRR_B_BK	111,00
Carbon lever protection (without adaptor) - Protezione leva in carbonio (senza adattatore)	LPLITE1_R	251,00
Oil cap - Tappo olio	T009_BK	39,00
10 ml Rear brake fluid reservoirs - Serbatoio fluido freno posteriore 10 ml	VS10P_BK	120,00
30 ml front fluid reservoir - Serbatoio fluido anteriore 30 ml	VS40_BK	196,00





DESCRIPTION - DESCRIZIONE

CODE - CODICE €

Rearsets- Pedane	TH07	596,00
Engine protections - Protezioni motore	CP119	305,00
Top triple clamp - Piastra di sterzo superiore*	PST1	502,00
Brake lever - Leva freno	LB210	161,00
Brake lever with remote adjuster - Leva freno con registro a sx	RALB210	279,00
Brake lever with Racing remote adjuster - Leva freno con registro Racing a sx	RALB210R	396,00
Clutch lever - Leva frizione	LC230	143,00
Complete Clutch lever - Leva frizione completa	LCF	190,00
Adjustable Complete Clutch lever - Leva frizione completa regolabile	LCFR	254,00
Levers kit - Kit leve	KL360	286,00
EVO lever protection (without adaptor) - Protezione leva EVO (senza adattatore)	LPRR2_BK	199,00
Lever protection (without adaptor) - Protezione leva (senza adattatore)	LPRR_B_BK	111,00
Carbon lever protection (without adaptor) - Protezione leva in carbonio (senza adattatore)	LPLITE1_R	251,00
Oil cap - Tappo olio	T009_BK	39,00
10 ml Rear brake fluid reservoirs - Serbatoio fluido freno posteriore 10 ml	VS10P_BK	120,00
30 ml front fluid reservoir - Serbatoio fluido anteriore 30 ml	VS40_BK	196,00

(*) Equipped with Bonamici Racing Nut, when mounting it is recommended to apply a light layer of grease.

(*) Dotata del dado Bonamici Racing, si consiglia al momento del montaggio del dado di applicare un leggero strato di grasso



DESCRIPTION - DESCRIZIONE

CODE - CODICE €

Rearsets- Pedane	Y011	571,00
Rearsetswith bracket for OEM Akrapovic exhaust Pedana con staffa per scarico Akrapovic OEM	Y011A	662,00
Bracket for OEM Akrapovic exhaust - Staffa per scarico Akrapovic OEM	SS_007A	183,00
Engine protections - Protezioni motore	CP047	467,00
Non-raised Clip-ons - Semimanubri bassi	SM50B	267,00
Top triple clamp "Standard" - Piastra di sterzo superiore "Standard"	PSY1	398,00
Top triple clamp "Race" - Piastra di sterzo superiore "Race"	PSY1R	349,00
Dashboard protection - Protezione strumentazione	DCP04	188,00
Brake lever - Leva freno	LB101	161,00
Clutch lever - Leva frizione	LC010	128,00
Complete Clutch lever - Leva frizione completa	LCF	190,00
Adjustable Complete Clutch lever - Leva frizione completa regolabile	LCFR	254,00
Levers kit - Kit leve	KL231	272,00
EVO lever protection (without adaptor) - Protezione leva EVO (senza adattatore)	LPRR2_BK	199,00
Lever protection (without adaptor) - Protezione leva (senza adattatore)	LPRR_B_BK	111,00
Carbon lever protection (without adaptor) - Protezione leva in carbonio (senza adattatore)	LPLITE1_R	251,00
Tank cap (black) - Tappo serbatoio (nero)	FC110_BK	118,00
Oil cap - Tappo olio	T007_BK	39,00
10 ml Rear brake fluid reservoirs - Serbatoio fluido freno posteriore 10 ml	VS10P_BK	120,00
30 ml front fluid reservoir - Serbatoio fluido anteriore 30 ml	VS40_BK	196,00
Chain adjuster - Tendicatena	CHAD03_BK	274,00
Swingarms spools - Supporti cavalletto	SCS6_BK	51,00
Swingarms spools "racing" - Supporti cavalletto "racing"	SCR6_BK	64,00

Some items can be purchased in colors other than standard black - Alcuni articoli possono essere acquistati in colori diversi dal nero standard



DESCRIPTION - DESCRIZIONE

CODE - CODICE €

Rearsets- Pedane	Y011	571,00
Rearsetswith bracket for OEM Akrapovic exhaust (2020/2022) Pedana con staffa per scarico Akrapovic OEM (2020/2022)	Y011A	662,00
Bracket for OEM Akrapovic exhaust - Staffa per scarico Akrapovic OEM	SS_007A	183,00
Engine protections - Protezioni motore	CP047	467,00
Non-raised Clip-ons - Semimanubri bassi	SM50B	267,00
Top triple clamp "Standard" - Piastra di sterzo superiore "Standard"	PSY1	398,00
Top triple clamp "Race" - Piastra di sterzo superiore "Race"	PSY1R	349,00
Dashboard protection - Protezione strumentazione	DCP04	188,00
Brake lever - Leva freno	LB101	161,00
Clutch lever - Leva frizione	LC010	128,00
Complete Clutch lever - Leva frizione completa	LCF	190,00
Adjustable Complete Clutch lever - Leva frizione completa regolabile	LCFR	254,00
Levers kit - Kit leve	KL231	272,00
EVO lever protection (without adaptor) - Protezione leva EVO (senza adattatore)	LPRR2_BK	199,00
Lever protection (without adaptor) - Protezione leva (senza adattatore)	LPRR_B_BK	111,00
Carbon lever protection (without adaptor) - Protezione leva in carbonio (senza adattatore)	LPLITE1_R	251,00
Tank cap (black) - Tappo serbatoio (nero)	FC110_BK	118,00
Oil cap - Tappo olio	T007_BK	39,00
10 ml Rear brake fluid reservoirs - Serbatoio fluido freno posteriore 10 ml	VS10P_BK	120,00
30 ml front fluid reservoir - Serbatoio fluido anteriore 30 ml	VS40_BK	196,00
Chain adjuster - Tencicatena	CHAD11_BK	274,00
Swingarms spools - Supporti cavalletto	SCS6_BK	51,00
Swingarms spools "racing" - Supporti cavalletto "racing"	SCR6_BK	64,00



DESCRIPTION - DESCRIZIONE

CODE - CODICE €

Rearsets- Pedane	Y012	430,00
Rearsets- Pedane* raised +40 mm compared to Y012	Y012_40	430,00
Raised Clip-ons ('15/'18) - Semimanubri rialzati ('15/'18)	SM41	254,00
Raised Clip-ons ('19/'25) - Semimanubri rialzati ('19/'25)	SM47	267,00
Brake lever - Leva freno	LB170	161,00
Brake lever with remote adjuster - Leva freno con registro a sx	RALB170	279,00
Clutch lever - Leva frizione	LC150	128,00
Complete Clutch lever - Leva frizione completa	LCF	190,00
Adjustable Complete Clutch lever - Leva frizione completa regolabile	LCFR	254,00
Levers kit - Kit leve	KL250	272,00
EVO lever protection (without adaptor) - Protezione leva EVO (senza adattatore)	LPRR2_BK	199,00
Lever protection (without adaptor) - Protezione leva (senza adattatore)	LPRR_B_BK	111,00
Carbon lever protection (without adaptor) - Protezione leva in carbonio (senza adattatore)	LPLITE1_R	251,00
Tank cap (black) - Tappo serbatoio (nero)	FC110_BK	118,00
Oil cap - Tappo olio	T007_BK	39,00
10 ml Rear brake fluid reservoirs - Serbatoio fluido freno posteriore 10 ml	VS10P_BK	120,00
30 ml front fluid reservoir - Serbatoio fluido anteriore 30 ml	VS40_BK	196,00
Swingarms spools - Supporti cavalletto	SCS6_BK	51,00
Swingarms spools "racing" - Supporti cavalletto "racing"	SCR6_BK	€ 64,00

(*) The brake hose needs to be replaced - (*) È necessario sostituire il tubo freno



Some items can be purchased in colors other than standard black - Alcuni articoli possono essere acquistati in colori diversi dal nero standard



DESCRIPTION - DESCRIZIONE

CODE - CODICE €

Rearsets- Pedane	Y013	501,00
Engine protections - Protezioni motore	CP025	422,00
Non-raised Clip-ons - Semimanubri bassi	SM50B	267,00
Raised Clip-ons - Semimanubri rialzati	SM50	267,00
Top triple clamp "Standard" - Piastra di sterzo superiore "Standard"	PSY2	398,00
Top triple clamp "Race" - Piastra di sterzo superiore "Race"	PSY2R	349,00
Brake lever - Leva freno	LB100	161,00
Brake lever with remote adjuster - Leva freno con registro a sx	RALB100	279,00
Clutch lever - Leva frizione	LC010	128,00
Complete Clutch lever - Leva frizione completa	LCF	190,00
Adjustable Complete Clutch lever - Leva frizione completa regolabile	LCFR	254,00
Levers kit - Kit leve	KL230	272,00
EVO lever protection (without adaptor) - Protezione leva EVO (senza adattatore)	LPRR2_BK	199,00
Lever protection (without adaptor) - Protezione leva (senza adattatore)	LPRR_B_BK	111,00
Carbon lever protection (without adaptor) - Protezione leva in carbonio (senza adattatore)	LPLITE1_R	251,00
Tank cap (black) - Tappo serbatoio (nero)	FC110_BK	118,00
Oil cap - Tappo olio	T007_BK	39,00
10 ml Rear brake fluid reservoirs - Serbatoio fluido freno posteriore 10 ml	VS10P_BK	120,00
30 ml front fluid reservoir - Serbatoio fluido anteriore 30 ml	VS40_BK	196,00
Chain adjuster - Tendicatena	CHAD07_BK	274,00
Swingarms spools - Supporti cavalletto	SCS6_BK	51,00
Swingarms spools "racing" - Supporti cavalletto "racing"	SCR6_BK	64,00
Gear spacer support - Supporto distanziale cambio	DC_037B	95,00



DESCRIPTION - DESCRIZIONE

CODE - CODICE €

Rearsets - Pedane	Y015	501,00
Non-raised Clip-ons - Semimanubri bassi	SM50B	267,00
Top triple clamp "Standard" - Piastra di sterzo superiore "Standard"	PSY3	398,00
Top triple clamp "Race" - Piastra di sterzo superiore "Race"	PSY3R	363,00
Top triple clamp Nut - Dado piastra di sterzo superiore	DD3	47,00
Dashboard protection - Protezione strumentazione	DCP16	193,00
Brake lever - Leva freno It can only be mounted on Bonamici Racing Clip-ons Code SM50B Può essere montata solo sui semimanubri Bonamici Racing Codice SM50B	LB220	172,00
Brake lever with remote adjuster - Leva freno con registro a sx	RALB220	290,00
Clutch lever - Leva frizione	LC010	128,00
Complete Clutch lever - Leva frizione completa	LCF	190,00
Adjustable Complete Clutch lever - Leva frizione completa regolabile	LCFR	254,00
Levers kit - Kit leve	KL340	299,00
EVO lever protection (without adaptor) - Protezione leva EVO (senza adattatore)	LPRR2_BK	199,00
Lever protection (without adaptor) - Protezione leva (senza adattatore)	LPRR_B_BK	111,00
Carbon lever protection (without adaptor) - Protezione leva in carbonio (senza adattatore)	LPLITE1_R	251,00
Tank cap (black) - Tappo serbatoio (nero)	FC110_BK	118,00
Oil cap - Tappo olio	T007_BK	39,00
10 ml Rear brake fluid reservoirs - Serbatoio fluido freno posteriore 10 ml	VS10P_BK	120,00
30 ml front fluid reservoir - Serbatoio fluido anteriore 30 ml	VS40_BK	196,00
Swingarms spools - Supporti cavalletto	SCS6_BK	51,00
Swingarms spools "racing" - Supporti cavalletto "racing"	SCR6_BK	64,00



Some items can be purchased in colors other than standard black - Alcuni articoli possono essere acquistati in colori diversi dal nero standard

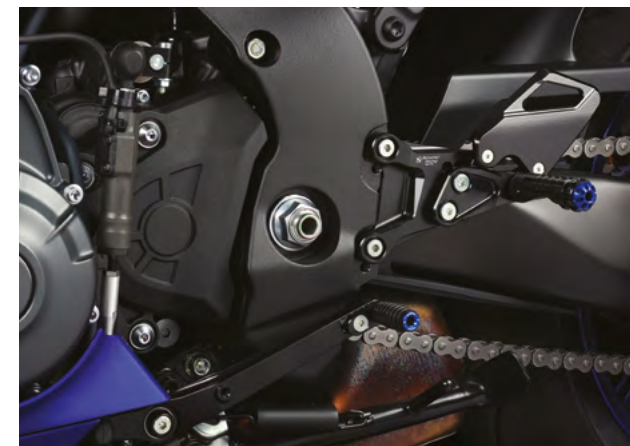

DESCRIPTION - DESCRIZIONE

CODE - CODICE €

Rearsets - Pedane	Y017	600,00
Non-raised Clip-ons - Semimanubri bassi	SM50B	267,00
Top triple clamp "Standard" - Piastra di sterzo superiore "Standard"	PSY4	398,00
Top triple clamp "Race" - Piastra di sterzo superiore "Race"	PSY1R	349,00
Dashboard protection - Protezione strumentazione	DCP26	201,00
Brake lever - Leva freno	LB280	174,00
Brake lever with remote adjuster - Leva freno con registro a sx	RALB220	290,00
Brake lever with racing remote adjuster - Leva freno con registro racing a sx	RALB220R	422,00
Clutch lever - Leva frizione	LC270	157,00
Complete Clutch lever - Leva frizione completa	LCF	190,00
Adjustable Complete Clutch lever - Leva frizione completa regolabile	LCFR	254,00
Levers kit - Kit leve	KL460	331,00
EVO lever protection (without adaptor) - Protezione leva EVO (senza adattatore)	LPRR2_BK	199,00
Lever protection (without adaptor) - Protezione leva (senza adattatore)	LPRR_B_BK	111,00
Carbon lever protection (without adaptor) - Protezione leva in carbonio (senza adattatore)	LPLITE1_R	251,00
Tank cap (black) - Tappo serbatoio (nero)	FC110_BK	118,00
Oil cap - Tappo olio	T009_BK	39,00
10 ml Rear brake fluid reservoirs - Serbatoio fluido freno posteriore 10 ml	VS10P_BK	120,00
30 ml front fluid reservoir - Serbatoio fluido anteriore 30 ml	VS40_BK	196,00
Chain adjuster - Tendicatena	CHAD17_BK	315,00
Chain adjuster with caliper support - Tendicatena con supporto pinza	CHAD17P_BK	372,00
Swingarms spools - Supporti cavalletto	SCS6_BK	51,00
Swingarms spools "racing" - Supporti cavalletto "racing"	SCR6_BK	64,00



DESCRIPTION - DESCRIZIONE

CODE - CODICE €

Rearsets- Pedane	Y016	501,00
Brake lever - Leva freno (2021-2023 models)	LB101	161,00
Clutch lever - Leva frizione (2021-2023 models)	LC010	128,00
Complete Clutch lever - Leva frizione completa	LCF	190,00
Adjustable Complete Clutch lever - Leva frizione completa regolabile	LCFR	254,00
Levers kit - Kit leve (2021-2023 models)	KL231	272,00
EVO lever protection (without adaptor) - Protezione leva EVO (senza adattatore)	LPRR2_BK	199,00
Lever protection (without adaptor) - Protezione leva (senza adattatore)	LPRR_B_BK	111,00
Carbon lever protection (without adaptor) - Protezione leva in carbonio (senza adattatore)	LPLITE1_R	251,00
Tank cap (black) - Tappo serbatoio (nero)	FC110_BK	118,00
Oil cap - Tappo olio	T008_BK	39,00
Swingarms spools - Supporti cavalletto	SCS6_BK	51,00
Swingarms spools "racing" - Supporti cavalletto "racing"	SCR6_BK	64,00
10 ml Rear brake fluid reservoirs - Serbatoio fluido freno posteriore 10 ml	VS10P_BK	120,00
30 ml front fluid reservoir - Serbatoio fluido anteriore 30 ml	VS40_BK	196,00



Some items can be purchased in colors other than standard black - Alcuni articoli possono essere acquistati in colori diversi dal nero standard

GENERAL TERMS OF USE AND PRODUCT WARNINGS

All third-party registered trademarks referenced herein are used exclusively for descriptive and identification purposes and remain the property of their respective owners.

All Bonamici Racing products are intended exclusively for racing use.

Every Bonamici Racing component is designed and manufactured entirely in Italy, using high-quality materials.

Bonamici Racing reserves the right to make technical changes or price adjustments to the products included in this catalogue at any time and without prior notice.

This catalogue is provided for general information only and does not constitute a contractual document.

All photos, images, and information contained in this catalogue are the exclusive property of Bonamici Racing; any improper or unauthorized use is strictly prohibited.

All Bonamici Racing products come with a 2-year warranty.

IMPORTANT WARNINGS

- Open the package with care. Installation must be carried out by qualified personnel equipped with proper tools.
- Carefully follow any instructions provided inside the package.
- Before using the product, ensure that all screws are securely tightened.
- Use threadlocker (Loctite) where required.
- Do not modify or tamper with any component under any circumstances.
- If you encounter any difficulty during installation, contact our company for support.

NOTE ON COLORED ANODIZED COMPONENTS

Bonamici Racing colored anodized components may show slight shade variations when compared to other items or reference images.

These color differences are a natural characteristic of the anodizing process, especially when products are manufactured in separate production batches.

Such variations do not affect the quality, performance, or durability of the product.

As a result, Bonamici Racing cannot guarantee exact color matching between anodized components from different production runs.

CONDIZIONI GENERALI DI UTILIZZO E AVVERTENZE PER I PRODOTTI BONAMICI RACING

I prezzi indicati nel catalogo sono espressi in euro e sono da intendersi IVA esclusa. I marchi registrati appartenenti a terzi sono citati unicamente per finalità descrittive. Tutti i prodotti Bonamici Racing sono destinati esclusivamente all'uso in competizione.

Ogni componente Bonamici Racing è progettato e realizzato al 100% in Italia, utilizzando materiali di elevata qualità.

Bonamici Racing si riserva il diritto di apportare in qualsiasi momento, e senza preavviso, modifiche tecniche o variazioni di prezzo ai prodotti presenti nel catalogo.

Il catalogo ha scopo informativo e non costituisce documento contrattuale.

Tutte le immagini, fotografie e informazioni contenute nel catalogo sono proprietà esclusiva di Bonamici Racing; ne è vietato l'utilizzo improprio o non autorizzato.

Tutti i prodotti Bonamici Racing sono coperti da 2 anni di garanzia.

AVVERTENZE IMPORTANTI

- Aprire la confezione con attenzione; il montaggio deve essere eseguito da personale specializzato dotato degli strumenti adeguati.
- Seguire con cura le eventuali istruzioni incluse nella confezione.
- Prima dell'utilizzo, verificare che tutte le viti siano serrate correttamente.
- Utilizzare frenafili (Loctite) dove necessario.
- Non modificare né manomettere in alcun modo i componenti.
- In caso di difficoltà durante l'installazione, contattare l'azienda per assistenza.

NOTA SUI COMPONENTI ANODIZZATI COLORATI

I componenti anodizzati colorati Bonamici Racing possono presentare lievi variazioni di tonalità rispetto ad altri articoli o immagini illustrative.

Tali differenze cromatiche sono una caratteristica naturale del processo di anodizzazione, specialmente quando i prodotti vengono realizzati in lotti produttivi differenti.

Queste variazioni non influenzano in alcun modo la qualità, le prestazioni o la durata del prodotto.

Pertanto, Bonamici Racing non può garantire la perfetta uniformità di colore tra componenti anodizzati appartenenti a produzioni diverse.

YOUR RIDE **YOUR** PERFORMANCE **OUR** PASSION



Bonamici Racing S.r.l.

info@bonamiciracing.it
sales@bonamiciracing.it
www.bonamiciracing.it
tel. +39.0744.71.91.32

Headquarters - Sede operativa:

Strada Flaminia sn. civ.
Z.I. Molette di Otricoli
05030 Otricoli (TR)
Italy

Registered office - Sede amministrativa:

Via Giovanni Battista Tiepolo, 21
00196 Roma (RM)
Italy